



Screening and Processing



Drying System



Wood Yard



Conveying solutions in the cement industry



Maintenance and Service



Waste to Fuel



Waste to Flame



Waste to Electricity



Biomass Fuel Handling



Pneumatic Conveying

INDUSTRIAL PROJECT AND SERVICE

www.ispm-service.com





ISPM-Service est une entreprise portugaise créée en 2015 sur un concept innovant et environnemental, orientée par des valeurs de développement durable dans une ère industrialisée où la production d'énergie grâce à la combustion des déchets est une manière de traiter le problème des déchets et d'en retirer un profit. **ISPM** est une entreprise flexible, enthousiaste, socialement responsable et adaptable aux changements. Notre entreprise se caractérise principalement par un effort commun: avec nos partenaires et représentants, nous concevons et assemblons des équipements et des projets «clés en main» dans plusieurs domaines. Nous avons une assistance technique avec des professionnels motivés et hautement qualifiés. Surmonter les défis, chercher à générer et implanter des nouvelles solutions technologiques, innovantes et out of the box font partie de nos préoccupations quotidiennes et de notre vision à long terme pour **ISPM-Service**. Nous sommes une entreprise visionnaire, nous travaillons aujourd'hui pour demain, le début de l'avenir.

**LA SOLUTION DE
L'AVENIR AU
PRÉSENT**

Paulo Teixeira



ISPM a été nommé officiellement revendeur de:

*BMH Technology au Portugal et en France;
Jeffrey Rader, Stela et Aumund au Portugal;
Demuth au Portugal, en Espagne et en France;
Et revendeur agréé de BMH au Brésil*



Waste to Flame

Les solutions Waste to Flame sont destinées aux cimentiers pour la production et la manutention de combustibles de récupération.

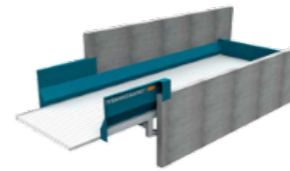

TYRANNOSAURUS® Feeders

Les alimentateurs Tyrannosaurus® permettent un chargement optimal de déchiqueteuses/broyeurs assurant ainsi continuellement une capacité maximale.



TYRANNOSAURUS® 1500 Fines Screens

Les cribles fins de la série 1500 de Tyrannosaurus® séparent les fines, comme le sable, le verre, la terre du matériau.



TYRANNOSAURUS® 6600 Pre-shredder

Pré-déchiqueteuses série 6600 de Tyrannosaurus®: idéales pour la préparation de déchets difficiles pour augmenter la capacité de votre processus ou comme déchiqueteuse principale pour une chaudière à grille.

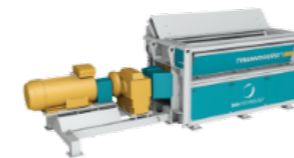

TYRANNOSAURUS® 1200 Fine Shredders

Les cribles fins de la série 1200 de Tyrannosaurus® sont utilisés pour réduire la granulométrie du produit à 0x25mm.



TYRANNOSAURUS® 2500 Air Classifiers

Les classeurs à air série 2500 de Tyrannosaurus® produisent une fraction légère et propre pour optimiser la qualité du combustible.



TYRANNOSAURUS® Rotating Screw Reclaimers

Les convoyeurs rotatifs Tyrannosaurus® conviennent au déchargement de combustibles solides de silos ou de stocks ronds à ciel ouvert.



Rotary Valve Feeders

Alimentateurs à valve rotatifs: la solution optimale pour alimenter et doser différents matériaux fins ou poussiéreux.

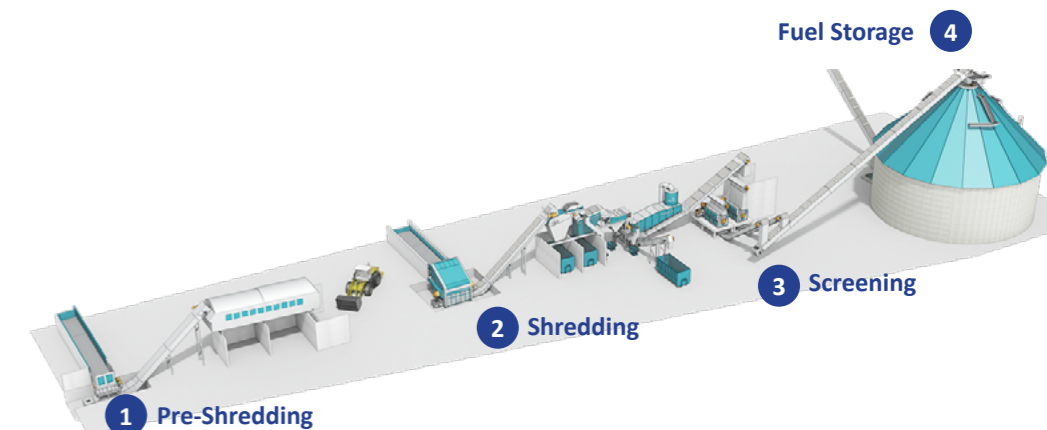

COMPLETE SYSTEM FOR SRF PRODUCTION AND UTILISATION IN CEMENT KILNS

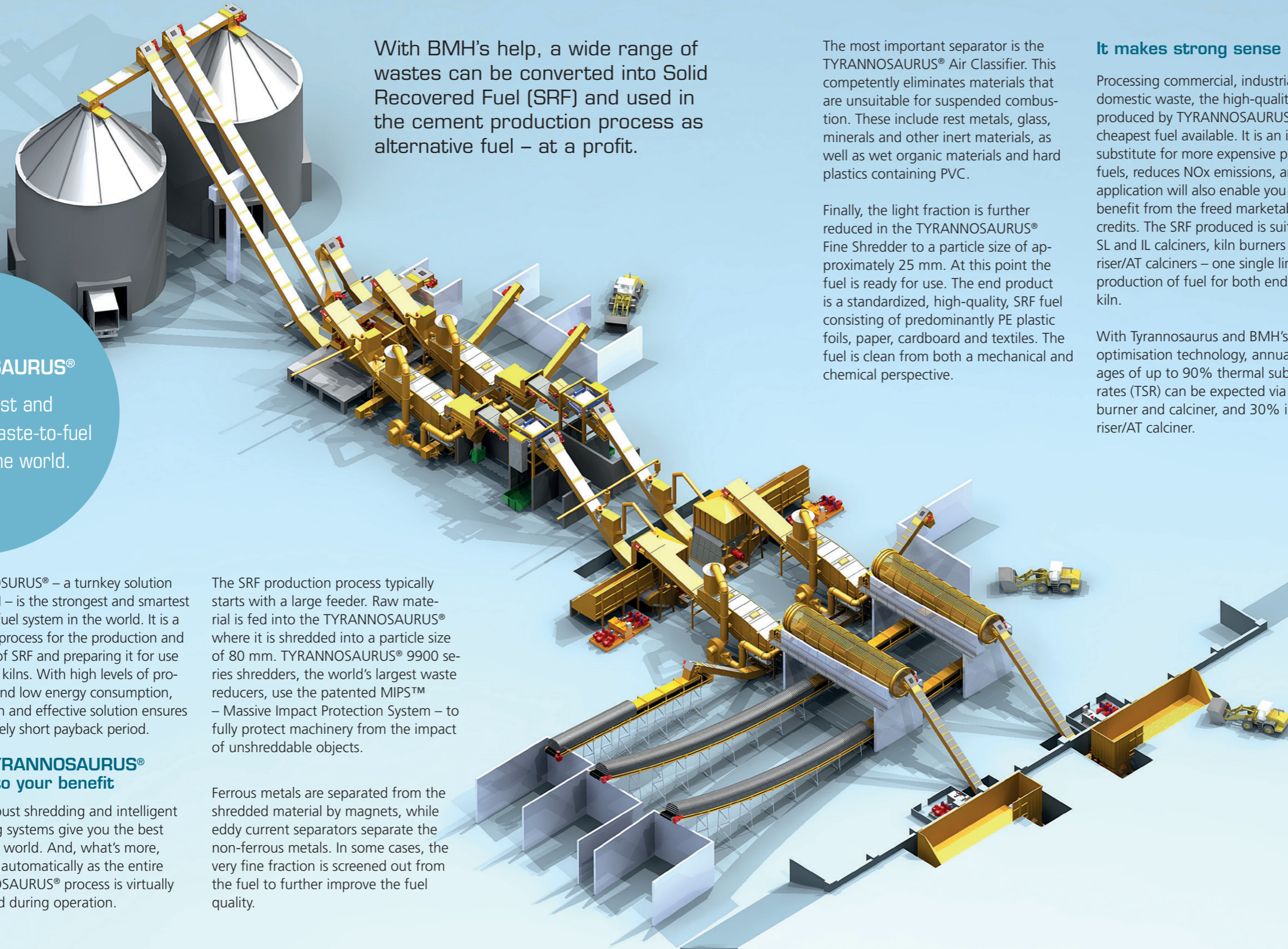
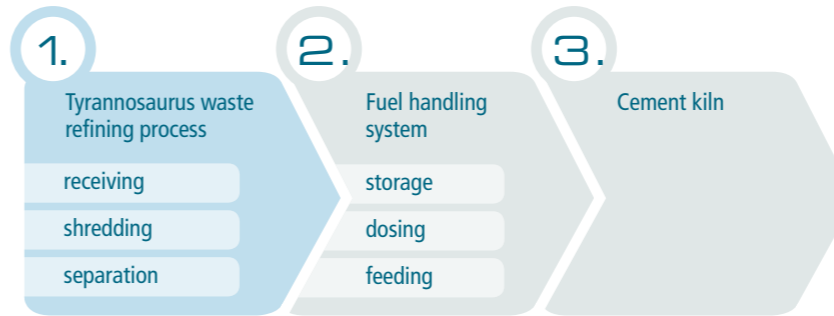

With BMH's help, a wide range of wastes can be converted into Solid Recovered Fuel (SRF) and used in the cement production process as alternative fuel – at a profit.

The most important separator is the TYRANNOSAURUS® Air Classifier. This competently eliminates materials that are unsuitable for suspended combustion. These include rest metals, glass, minerals and other inert materials, as well as wet organic materials and hard plastics containing PVC.

It makes strong sense

Processing commercial, industrial and domestic waste, the high-quality SRF produced by TYRANNOSAURUS® is the cheapest fuel available. It is an ideal substitute for more expensive prime fuels, reduces NOx emissions, and its application will also enable you to benefit from the freed marketable CO₂ credits. The SRF produced is suitable for SL and IL calciners, kiln burners and gas riser/AT calciners – one single line for the production of fuel for both ends of the kiln.

Finally, the light fraction is further reduced in the TYRANNOSAURUS® Fine Shredder to a particle size of approximately 25 mm. At this point the fuel is ready for use. The end product is a standardized, high-quality, SRF fuel consisting of predominantly PE plastic foils, paper, cardboard and textiles. The fuel is clean from both a mechanical and chemical perspective.

With Tyrannosaurus and BMH's process optimisation technology, annual averages of up to 90% thermal substitution rates (TSR) can be expected via the main burner and calciner, and 30% in a gas riser/AT calciner.



By mandate of European commission: EN 15359.

Not only is SRF the cheapest fuel available, but its application will also enable you to benefit from the freed marketable CO₂ credits.

TYRANNOSAURUS®

The strongest and smartest waste-to-fuel system in the world.

TYRANNOSAURUS® – a turnkey solution from BMH – is the strongest and smartest waste-to-fuel system in the world. It is a complete process for the production and handling of SRF and preparing it for use in cement kilns. With high levels of productivity and low energy consumption, this proven and effective solution ensures an extremely short payback period.

How TYRANNOSAURUS® works to your benefit

BMH's robust shredding and intelligent separating systems give you the best SRF in the world. And, what's more, they do it automatically as the entire TYRANNOSAURUS® process is virtually unmanned during operation.

The SRF production process typically starts with a large feeder. Raw material is fed into the TYRANNOSAURUS® where it is shredded into a particle size of 80 mm. TYRANNOSAURUS® 9900 series shredders, the world's largest waste reducers, use the patented MIPS™ – Massive Impact Protection System – to fully protect machinery from the impact of unshreddable objects.

Ferrous metals are separated from the shredded material by magnets, while eddy current separators separate the non-ferrous metals. In some cases, the very fine fraction is screened out from the fuel to further improve the fuel quality.

THE WORLD'S BEST FUEL HANDLING SYSTEM

When waste has successfully been processed into SRF, the fuel continues its onward journey towards the cement kiln. The turn-key TYRANNOSAURUS® plant includes fuel production systems, automatic storage and conveyor systems as well as dryers, dosing and kiln feeding systems.

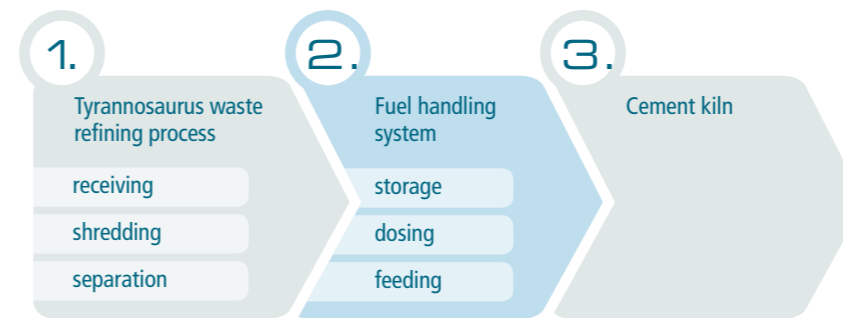

SRF logistics is a vital part of the TYRANNOSAURUS® process. With all parts of the process provided by one supplier, the equipment and automation work seamlessly together to ensure the efficient handling of fuel, and getting it safely to where it's needed most – the cement kiln.

Storage and conveying fuel to the kiln

If the SRF production plant is located close to the cement kiln, the fuel can be transported directly to the kiln by chain or tubular belt conveyors. Bucket elevators are available for vertical transport. In some cases, screw conveyors are ideal. All conveyor types are designed in an entirely enclosed manner to eliminate material spillage. In the case of longer distances, the SRF fuel is usually transported by trucks.

The most straightforward storage solution is to use truck trailers as an intermediate storage option for the fuel. The truck leaves its trailer at the kiln for controlled discharge directly into the kiln through a mechanical or pneumatic system. The TYRANNOSAURUS® process can be fitted with fully automatic truck docking stations or, alternatively, intermediate storage bunkers.

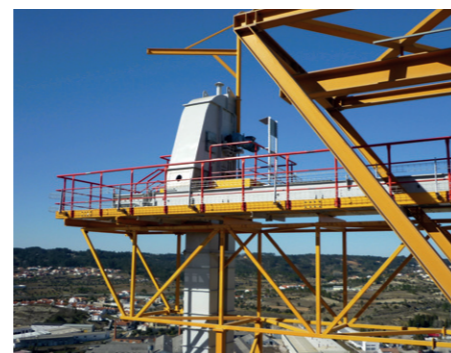

SRF can also be compacted into plastic-wrapped 'energy cubes' which are highly efficient to transport. Energy cubes also provide an ideal long-term storage solution.

In addition, silos with automatic discharge facilities can be built at the kiln site. If larger storage volumes are required, they can be achieved by building a multiple silo complex.

Dosing and feeding into kiln

Both pneumatic and mechanical feeding systems are available. The pneumatic system includes a dosing hopper with accurate flow control. SRF fuel is fed into a rotary valve from where it is injected into the pneumatic system and further into the process.

The mechanical systems include receiving bunkers, silos, dosing and flow monitoring. They are designed and dimensioned so that the process can receive a wide range of substitute fuels. Special attention is paid to ensuring that the flow of fuel is undisturbed and controlled.

For calciner, the SRF can be supplied to more than one location. The injection system supplemented with a jet air mixing sleeve ensures an optimum mixing and combustion of the SRF with the tertiary air and kiln gases.



BMH – THE ALTERNATIVE FUEL SPECIALIST

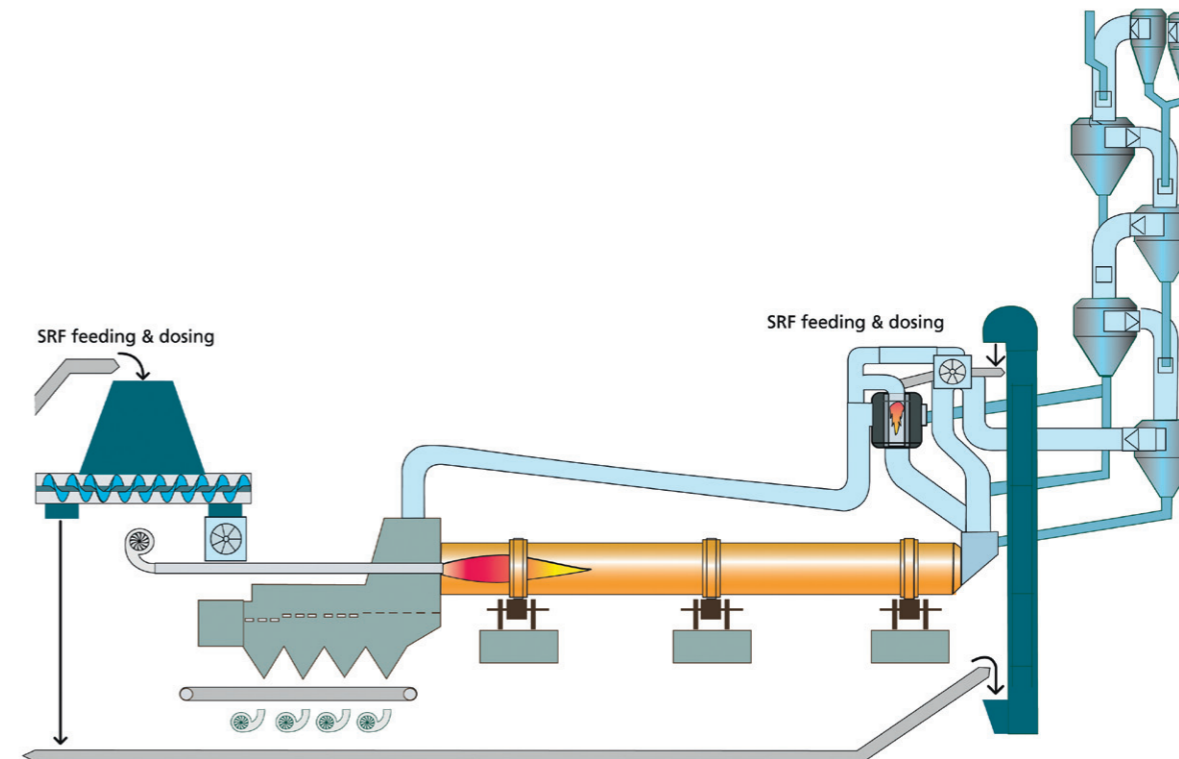
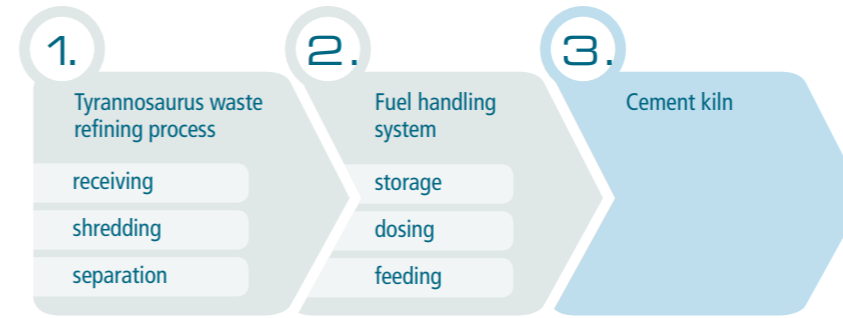
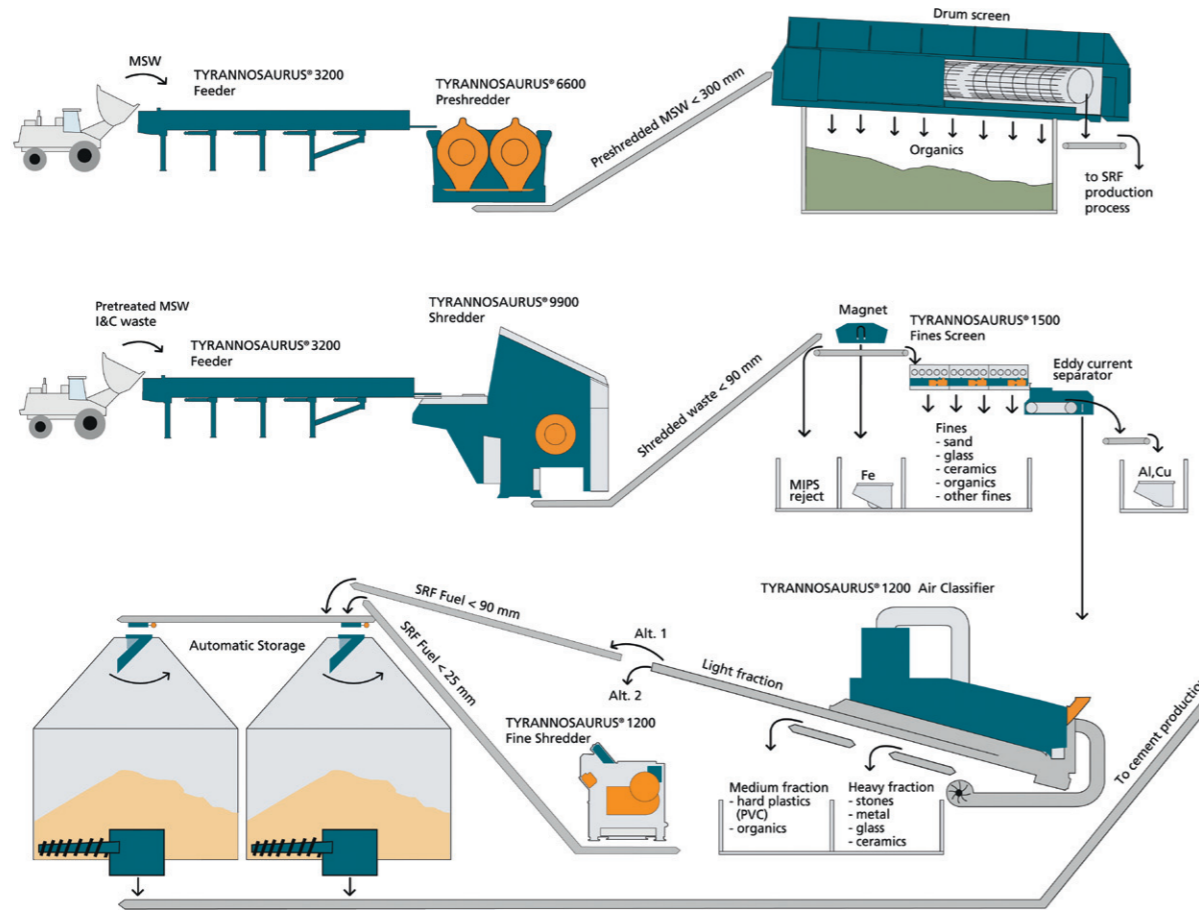

BMH provides you with all the technical solutions you require. Our considerable expertise starts at the waste receiving procedure and ends with the controlling of the SRF into the cement process.

By choosing BMH, you are choosing a complete service. Projects are well managed, and deliveries are made on time and within budget. In addition, BMH has the skills to help you evaluate the impact of SRF, for example, on your process, output, emission and clinker quality, and to analyse the financial benefits.

Impact on process

BMH's solutions customise SRF and its implementation to individual cement plant processes and chemical characteristics. SRF is injected into a burner that is optimally set up and has the appropriate momentum for the kiln output. This stops SRF from being dumped into the burning zone, prevents reduced clinker and increased build up issues, and ensures high thermal substitution rates (TSR) are achievable.

For the calciner it is more complicated as most plants are different and the injection locations and their modes for the SRF to get higher TSRs are most important. BMH will guide you for all types of calciners to maximise the use of SRF without impact on output and SO₃ cycles and build-up.

Impact on emissions

SRF with its potential for high TSRs can be factored into longer term planning for CO₂ credits and/or trading. CO and even VOC increases can be an issue for plants that do not have BMH's quality or preparation and feeding control, plus its optimised SRF injection.

Generally all alternative fuels and raw materials (AFR) show a reduction in NO_x. However the SRF preparations together with hot reburn potential can leave many plants not needing selective non-catalytic reduction (SNCR) to meet their NO_x permits. BMH can advise on how to optimise the drop in NO_x potential for SRF.

Impact on clinker quality

Coarse ash is an issue that can limit the use of AFR, due to the need to get it into solid solution. BMH minimises inerts in SRF by separation during processing.

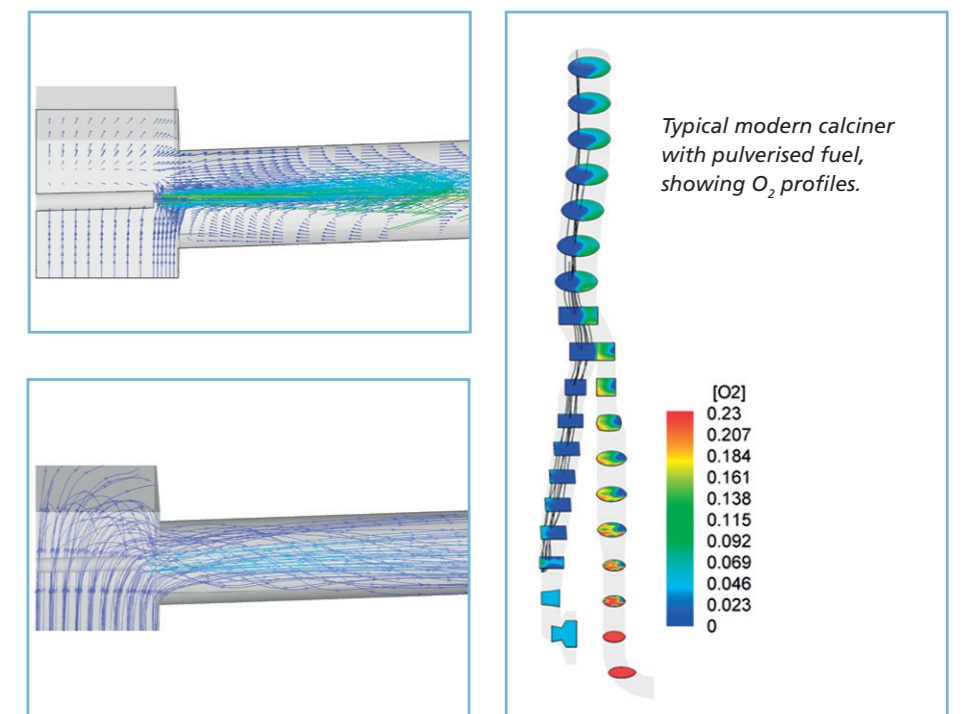

Bucket elevators are an excellent choice particularly in locations where space is limited and material needs to be transferred high on a vertical scale. They are capable of lifting a variety of materials ranging from dry, dusty fluff to heavy materials such as bottom ash.

Bucket elevators are always custom designed to meet your specific requirements and to suit the materials being handled.

Main advantages

- outstanding lifting capacity to high altitudes in confined spaces
- totally enclosed construction provides dust-tight and spillage-free operation
- specially designed buckets ensure clean and perfect discharge
- customised solutions based on modular engineering for fast and cost-effective installation
- long lifetime

BELT BUCKET ELEVATOR	
Belt width (mm)	Max capacity (m ³ /h)
500	100
650	150
800	250
1000	400
1200	600
1400	900

Please note that the capacity values in this table are only indicative and they have been calculated for handling woodchip or similar materials.

CHAIN BUCKET ELEVATOR	
Casing size (mm)	Max. capacity (m ³ /h)
400 x 1000	40
720 x 1000	80
900 x 1250	120

Please note that the capacity values in this table are only indicative and they have been calculated for handling lime or similar materials.

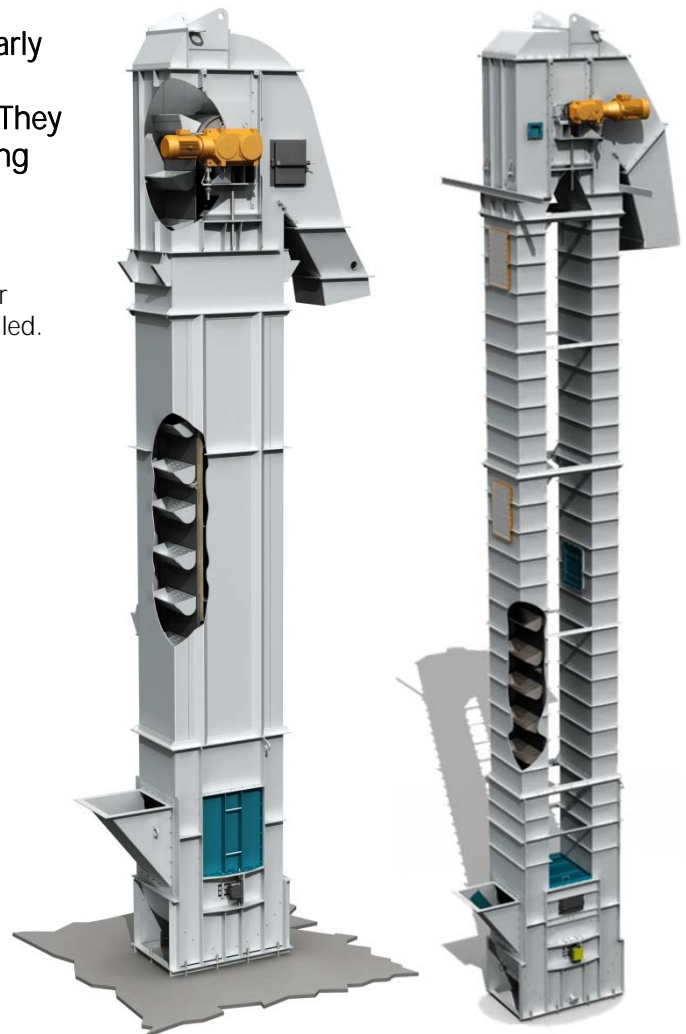

IDEAL FOR HANDLING:

Belt bucket elevators

- biomass fuels (woodchips, bark, peat, agro biomass, pellets)
- solid recovered fuel (SRF)

Chain bucket elevators

- cement
- lime
- ash

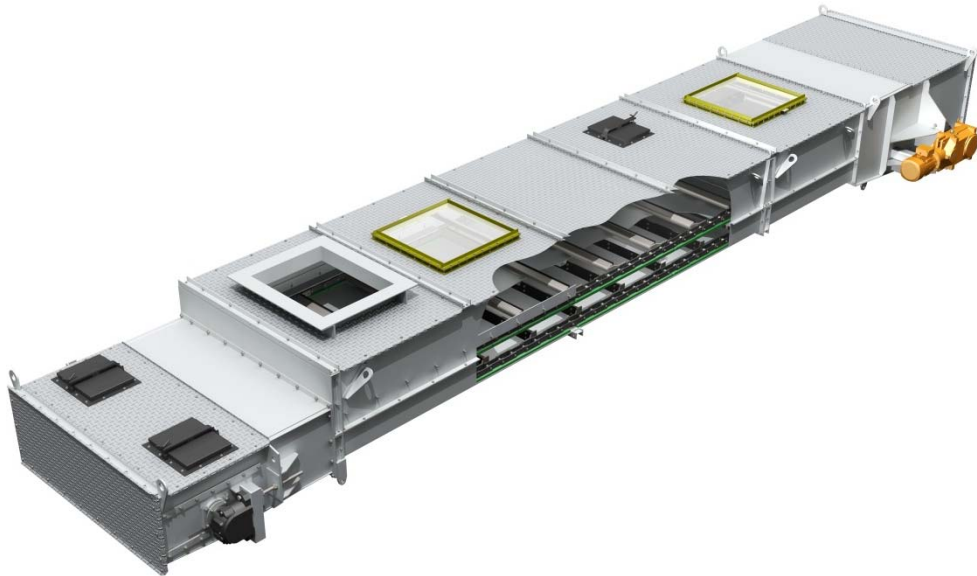

Drag chain conveyors provide a safe and reliable solution for handling powdery and dusty bulk materials in various industrial processes that require a continuous and even material flow.

Drag chain conveyors efficiently meet your needs in the following areas:

- receiving of material and transferring to intermediate storage
- filling of storage silos
- discharging from storage silos and further feeding to process equipment
- transferring of end product to storage

Width (mm)	Capacity (m ³ /h)	Recommended max. length (m)
650	150	60
800	200	60
1000	300	60
1200	400	60
1400	500	60
1600	700	60
2000	1000	60

Please note that the values in this table are only indicative. The capacities have been calculated for handling woodchip or similar materials.

IDEAL FOR HANDLING:

- biomass fuels (woodchips, bark, peat, agro biomass, pellets)
- solid recovered fuel (SRF)
- coal
- ash
- cement
- lime and minerals

Main advantages

- customised solutions based on modular engineering for fast and cost-effective installation
- horizontal or inclined installations, or a combination of both
- several inlet and outlet points
- standard components and chain types
- forged chains for heavy-duty applications
- special chains for heavy-duty and demanding conditions (heatproof structures)
- possibility to include water-cooling designs
- simple construction for straightforward maintenance
- dust-tight and spillage-free

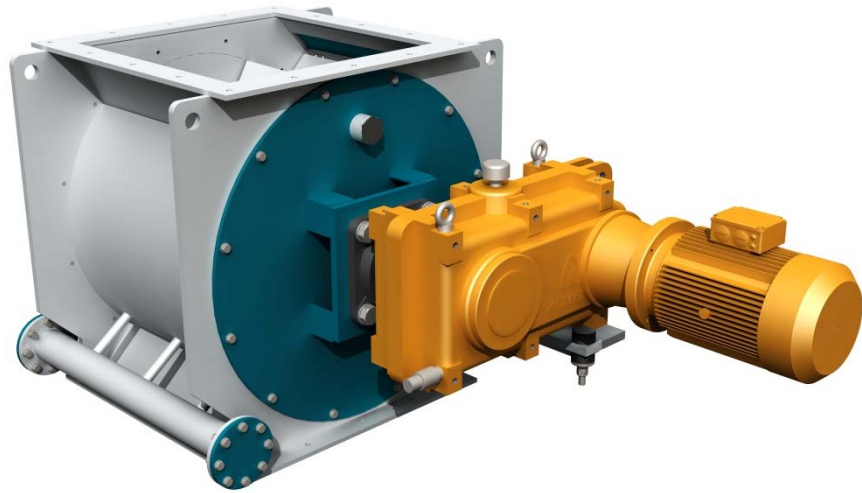

Rotary valve feeders are widely used in feeding and dosing fine-grained and dusty materials in various processes. They are always custom designed to meet your specific applications and to suit the materials being handled.

Rotary valve feeders feed e.g. coal, SRF, biomass or fly ash into a power boiler and, at the same time, act partially as a lock to prevent the backflow of gases and flames. They also serve as a dosing feeder at the silo outlet to prevent the uncontrolled discharge of material out of the silo.

Main advantages

- modular robust design with standard components
- reliable operation
- totally enclosed, dust-tight and safe construction
- easy installation
- minor need for maintenance

Special models available for your specific needs:

- LSE – Electric precipitator soda ash

TYPE	Size	Capacity (m ³ /h)
LSF Biomass, solid recovered fuel (SRF)	40/60	40
	50/60	60
	50/80	85
	63/50	100
	63/80	140
	80/80	200
	63/120	230
LSC Coal, sludge, sticky materials, (biomass)	80/120	300
	40/40	20
	40/50	30
	40/60	40
	50/60	60
	63/50	60
LSAR Ash, sand	63/80	100
	20/20	5
	30/30	15
	40/40	40
	50/50	80

Please note that the values in this table are only indicative and they have been calculated for a filling degree of 40%.

IDEAL FOR HANDLING:

- biomass fuels (woodchips, bark, peat, agro biomass, pellets)
- solid recovered fuel (SRF)
- coal
- sludge
- sticky materials
- ash
- sand

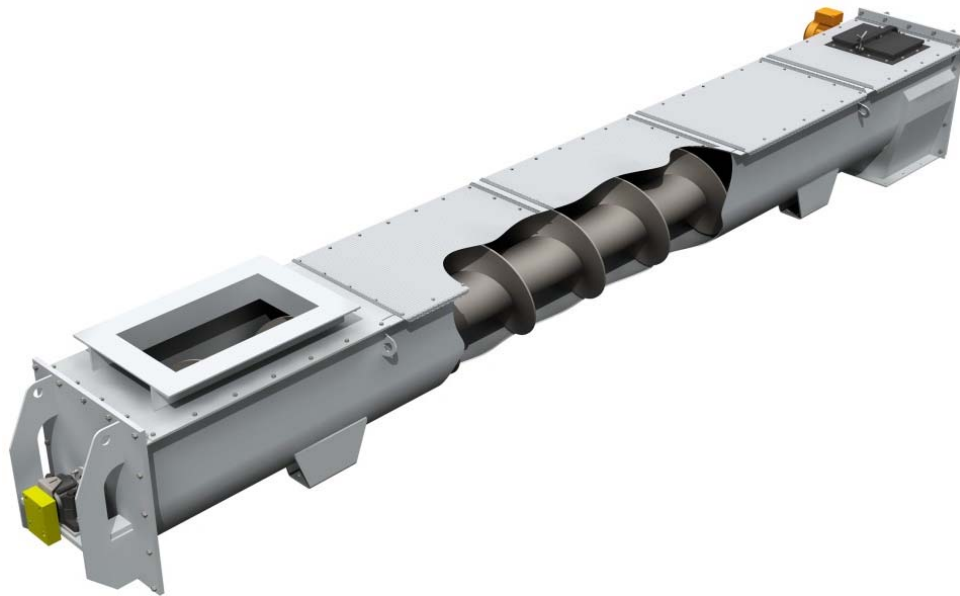

Screw conveyors are one of the most economical ways to transfer bulk materials over short distances.

Besides transferring materials from one place to another, screw conveyors can be used for:

- feeding, dosing and mixing
- distribution of material flow
- cooling (double-wall special design)
- humidifying (when equipped with internal water nozzles)
- vertical lifting of certain materials

Screw conveyors are designed to meet your specific usage requirements and to suit the materials being handled.

Screw diameter (mm)	Capacity (m ³ /h)	Recommended max. length
250	15	6.5
315	26	7.0
400	55	8.5
500	110	8.6
630	220	10.0
710	300	11.0
800	330	11.0
900	450	11.0
1000	520	12.0
1120	740	12.0
1250	850	12.0
1400	1200	14.0
1600	1400	14.0

Please note that the values in this table are only indicative. The capacities have been calculated for handling woodchip or similar materials at an inclination of 0°.

IDEAL FOR HANDLING:

- biomass fuels (woodchips, bark, peat, agro biomass, pellets)
- solid recovered fuel (SRF)
- coal
- ash
- cement
- lime and minerals

Main advantages

- standard modular design
- horizontal, inclined and vertical designs
- tubular or U-shaped conveyor trough
- special design flights for difficult sticky materials
- screws with wear-resistant facing for demanding conditions
- simple construction means easy maintenance

TYRANNOSAURUS® 6600 PRESHREDDERS



TYRANNOSAURUS® 6600 Preshredders are the best solution available on the market for rough shredding of material during pre-treatment. They are designed to open e.g. plastic bags and crush the MSW (Municipal Solid Waste) into a smaller particle size which then allows proper separation in the drum screen. TYRANNOSAURUS® 6600 Preshredders can also operate as the main shredder for grate fired incinerators.

The hydraulically operated TYRANNOSAURUS® 6600 Preshredders present an extremely robust construction specially designed for industrial purposes. Incorporating a pre-shredder into the process will increase the capacity of the entire production line.

TYPE	Rotor length (mm)	Capacity (t/h)
6603	1900	25–50
6604	2500	35–70
6605	3200	50–90

Please note that the capacity values in this table are only indicative.

IDEAL FOR SHREDDING:

- municipal solid waste (MSW)
- waste with high water content

Main advantages

- works in demanding conditions and with high water content materials
- designed to prevent material from tangling; reliable operation
- easily exchangeable knives; easy maintenance
- low operating and maintenance cost
- high capacity; adds the capacity of the entire process line



TYRANNOSAURUS® Circular Screw reclaimers LPE have been developed to discharge material both from silos and round, open-air storage facilities.

TYRANNOSAURUS® Circular Screw reclaimers LPE are designed to efficiently meet your needs in the following areas:

- automatic fuel reclaiming and even flow of material from storage
- capacity can be easily adjusted to process requirements

TYPE	Max capacity (m ³ /h)	Silo diameter (m)
LPE10	70	4-5
LPE20	250	4.5-7
LPE25	350	5-7
LPE30	700	8-12
LPE35	700	12-14
LPE40	800	12-16
LPE50	900	18-25
LPE55	900	26-27

Please note that the values in this table are only indicative. The capacities have been calculated for handling woodchip and similar materials.

IDEAL FOR HANDLING:

- biomass fuels (woodchips, bark, peat, agro biomass, pellets)
- solid recovered fuel (SRF)

Main advantages

- heavy-duty construction to ensure a long lifetime
- constructed from materials and equipped with special linings which best suit the use
- screws are equipped with fixed or replaceable teeth
- specially designed teeth for demanding applications
- easy access to service points and simple maintenance
- central lubrication unit
- simple and inexpensive foundations

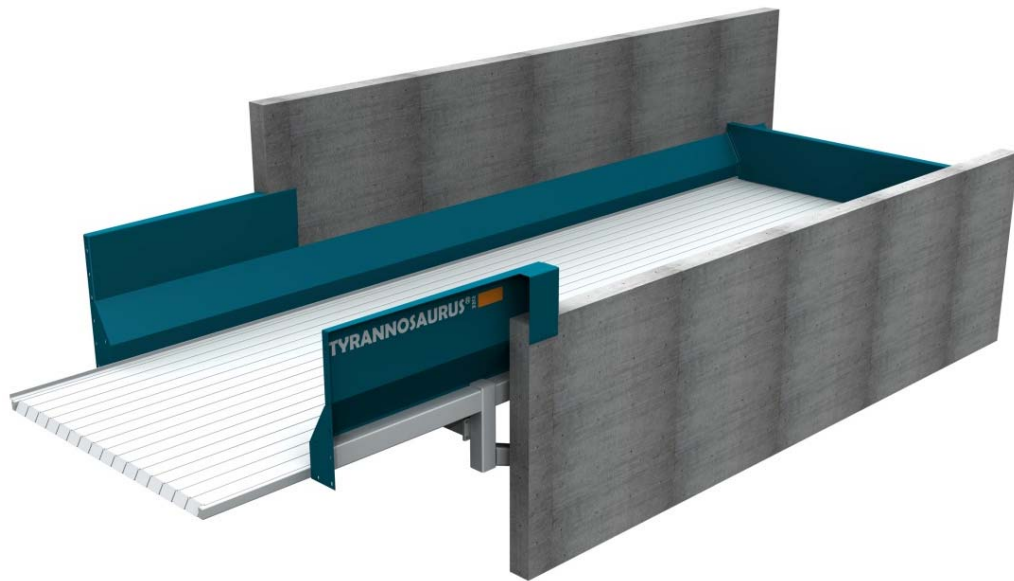

TYRANNOSAURUS® Step Feeders are an excellent solution for optimising almost any feeding process where a continuous flow of material is needed. They are typically combined with a TYRANNOSAURUS® Shredder or a TYRANNOSAURUS® Biocrusher. A step feeder serves a buffer and a feeder for the process lengthening the loading intervals and enabling the front loader driver to take on more profitable tasks between loadings.

When attached for example to a shredder, TYRANNOSAURUS® Step Feeders can adjust their feeding capacity according to the level measurements taken in the shredder's feed hopper. This means the production capacity is kept at its maximum level all the time. Step feeders are not only capable of handling large pieces but also carrying a huge volume of material. The fully automatic feeding ensures that the process functions are constantly optimised.

TYPE	Width (mm)	Length (m)	Capacity (m³/h)
2412	2400	12	45
2418	2400	18	65
2424	2400	24	85
3212	3200	12	60
3218	3200	18	85
3224	3200	24	115

Please note that the values in this table are only indicative and they have been calculated for handling MSW. The thickness of the material layer used in the calculation was 1.5 m.

TYRANNOSAURUS® Step Feeders have a long lifetime. The number of wear parts has been minimised resulting in low operation and maintenance costs.

SUITABLE FOR ALMOST ANY SOLID MATERIAL:

- municipal solid waste (MSW)
- industrial waste
- demolition waste wood
- bark
- stumps
- biomass

Main advantages

- high availability and long lifetime
- low investment and operating costs
- low maintenance costs
- high buffer capacity
- loading intervals lengthened
- produces an even material flow to the next process
- designed to prevent material from tangling
- efficient operation
- heavy duty design
- easy to install

www.ispm-service.com

PORTUGAL

+351 234 304 197
Rua Dr. Alberto Soares Machado, 89
Apartado 512, EC Avenida
3801-901 Aveiro | Portugal

ispm@ispm-service.pt

FRANÇA

+33 1 43 34 81 72
+33 6 11 10 50 91
5 Place Charras Apt 67
92.400 Courbevoie | France

drousseau@ispm-service.pt

BRASIL

+55 31 2527 4426
Três Corações, 136/1004
Belo Horizonte - MG
30411-239 | Brasil

dieter.dombrowski@ispm-service.pt

