



Screening and Processing



Drying System



Wood Yard



Conveying solutions in the
cement industry



Maintenance and
Service



Waste to Fuel



Waste to Flame



Waste to Electricity



Biomass Fuel Handling



Pneumatic Conveying

INDUSTRIAL PROJECT AND SERVICE

www.ispm-service.com



ISPM-Service is a portuguese company born in 2015 with an environmental and innovative concept, guided by values that encourage sustainable development in an industrialized Era, where the generation of energy from waste is not only a way to ensure the future of the planet, but also a mean to profit. ISPM is a flexible, enthusiastic, socially responsible organization and adaptable to the changes. Our business is characterized mainly for a joint effort with our business partners. Together we design, produce, and assemble equipment and turn-key projects in various areas. Our technical assistants are motivated and highly qualified professionals. Overcoming challenges and searching for the generation and implementation of technological, innovative, and out-of-the-box business solutions, are on our day-to-day basis and part of our longterm vision for **ISPM-Service**. We are a visionary company, we work today for tomorrow as the beginning of the future.

**THE FUTURE'S
SOLUTION
TODAY**

Paulo Teixeira

ISPM has been named Official Reseller Of:

*BMH Technology in Portugal and France;
Jeffrey Rader, Stela and Aumund in Portugal;
Demuth in Portugal, Spain and France.*



Conveying solutions in the cement industry

AUMUND Fördertechnik is the specialist in transport and storage solutions for difficult bulk materials. Where technological demand and highest availability go hand in hand, AUMUND Fördertechnik is often in the field. For about the last 90 years special areas of emphasis have evolved: Cement, Lime and Gypsum Metallurgy Power Stations Minerals and Mining



Bucket elevators

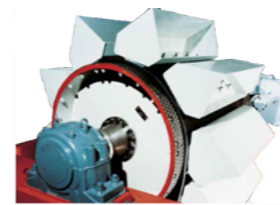

Belt Bucket Elevator (BWG)

The belt bucket elevator type BW-G are equipped with specially developed steel-rope belts permitting a long lifespan and heat resistance up to 130° Celsius.



Central Chain Bucket elevator (BWZ)

The bucket elevator with forged central chain (type BWZ) is configured for the transport of all types of coarse, hot or abrasive bulk materials.

Chain Conveyor

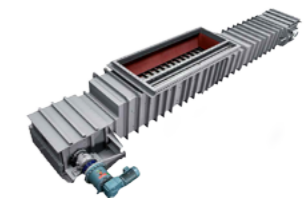

Coal Mill Feeding

For coal mill feeding applications, all Chain Conveyors come in a shock-pressure proof design resisting to 3.5 bar on a standard basis.

Pan Conveyors



Deep drawn pan conveyor (KZB)

The deep drawn pan conveyor (type KZB) is a perfectly reliable and economic means of conveying hot or abrasive bulk materials.



Bucket Apron Conveyor (BZB)

The bucket apron conveyor (type BZB) is the optimum solution for conveying at up to 60° gradient angle.



Samson® Material Feeder

The Samson® surface feeder extracts bulk materials directly from the truck, but is also used for wagon unloading as well as in bulk material handling with front-end loaders.

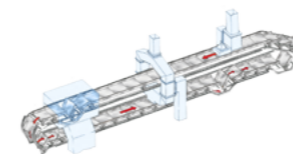

Pivoting Pan Conveyor (SPB)

The AUMUND pivoting pan conveyor is the perfect medium for selective intake, wherever emptying into more than two silos or bunkers is required.

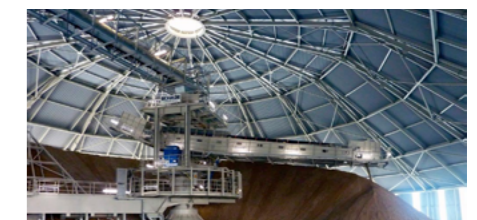



Bucket Elevators

CONTENT

2	AUMUND Bucket Elevators
----------	-------------------------

4	Bucket Elevator with Central Chain Type BWZ
----------	--

8	Double Bucket Elevator Type BWZ-D
----------	--------------------------------------

10	Belt Bucket Elevator Type BWG
-----------	----------------------------------

14	Conversions and Refurbishments
-----------	--------------------------------

15	After Sales Service
-----------	---------------------

AUMUND Bucket Elevators

Throughout more than 90 years of industrial construction, AUMUND has been a trendsetter in conveying technology and offers products of high technical standard and solutions for a variety of applications wherever conveying and storing of bulk materials is required.

AUMUND expertise is acknowledged by customers in all major industries in more than 100 countries.

Availability, service life and low operating costs are key issues for the plant operator.

AUMUND Bucket Elevators, tailor made and continuously developed to suit ever increasing plant and process requirements, offer this availability combined with performance, flexibility and service life.

With their proven quality, strength and reliability AUMUND Bucket Elevators have become a synonym for efficient vertical transport of any kind of bulk material under severe operating conditions and in continuous operation.

- Limestone
- Aggregates
- Clinker
- Slag
- Cement
- Gypsum
- Coal
- Ores
- Fly ash
- Raw meal
- others





Bucket Elevator for cement silo feeding

Bucket Elevator with Central Chain Type BWZ

The prominent features of the AUMUND Bucket Elevator type BWZ are the forged central chain and a close bucket spacing. The bulk material is fully taken by the buckets and discharged in a continuous manner to the subsequent conveying systems.

The forged chains feature labyrinth seals and a lubricated bolt and bush connection. The symmetrical

design of the chain links, which are fabricated from high-quality forgings, contributes to a long service life.

The buckets are fixed to the chain by means of brackets connected with the chain bolt in a loose fitting. Transmission of vibrations is considerably reduced and the mounting of buckets is simple and easy.

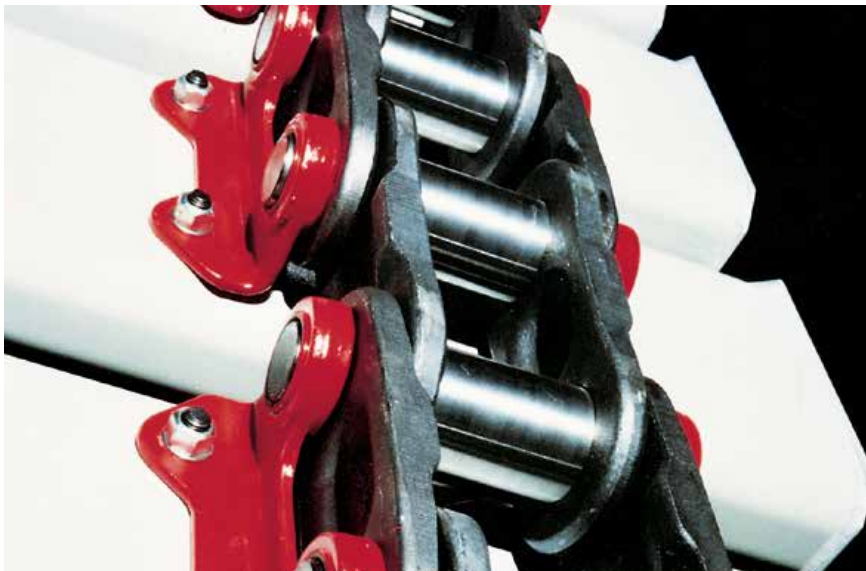

Central chain with brackets

Characteristic features of AUMUND Bucket Elevators with Central Chain

- Conveying capacities exceeding 1,100 m³/h
- Lifting heights to 90 m
- Forged central chain with large link surface (AU06 - AU19)
- Angular brackets for easy bucket fixing (AU04 - AU19)
- Segmented drive ring
- Assembly casing for easy access
- Outstanding service life – in continuous operation
- Low maintenance
- High degree of availability



Drive ring supporting chain bush and links

Central Chains for Type BWZ and BWZ-D

Type	Chain pitch (mm)	Breaking load (kN)
AU01	140.0	400
AU02	152.4	540
AU04	177.8	800
AU06	177.8	1,200
AU13	177.8	1,500
AU15	177.8	1,800
AU19	200.0	2,450

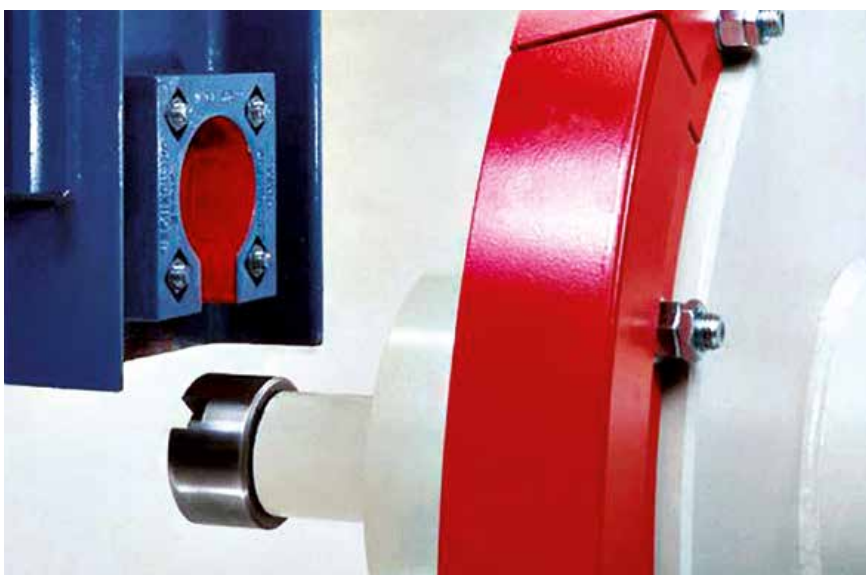

Tension wheel bearing

The chain tensioning box consists of the guide frame and the tail shaft with integrated tension weight.

AUMUND uses the anti-friction bearing concept with benefits in both life and ease of maintenance.



Bucket elevator head with single drive



Bucket Elevator Type BWZ handling puzzolana and limestone

Bucket Elevator with Central Chain Type BWZ – High Performance Elevators

The indicated conveying capacities correspond to a 100% bucket filling (water filling)

Bucket				Drive Ring ø [mm]				
				790	1,005	1,115	1,215	
Width [mm]	Pro- trusion [mm]	Volume [dm ³]	Spacing [mm]	Conveying speed [m/s]				
				1.40	1.60	1.77	1.92	
				Conveying capacity [m ³ /h]				
400	320	18.80	AU 04	266	305	337	365	
450		21.10		299	342	378	410	
500		23.50		AU 06	333	381	421	457
560		26.30		AU 13	373	426	471	511
630		29.60	AU 15	420	480	531	576	
710		33.40	355.6	473	541	598	649	
800		37.60		533	609	674	731	
900		42.30		600	686	759	823	
1,000		47.00		666	761	842	913	
1,100		51.70		733	838	927	1,005	
1,200		56.40		800	914	1,011	1,097	



AUMUND Bucket Elevators with central chain are the ideal solution to raise granular, coarse and abrasive materials.

With bucket widths ranging from 210 mm to 1,200 mm they can handle a broad scope of conveying capacities up to more than 1,100 m³/h.

All AUMUND Bucket Elevators feature a large assembly casing with easy access.

Assembly casing with hinge-supported door for easy maintenance

Bucket Elevator with Central Chain Type BWZ – Low to Medium Duty

The indicated conveying capacities correspond to a 100% bucket filling (water filling)

Bucket

Width [mm]	Protrusion [mm]	Volume [dm ³]	Spacing [mm]	Drive Ring [ø mm]	Conveying speed [mm]	Max. Capacity [m ³ /h] 100 %
210	250	5.50	AU 01	600	1.23	87
250		6.55				104
280		7.33				116
315		8.25				130
355		9.30				147
400		10.50				166
315	250	9.33	AU 02	730	1.49	164
355		10.50				185
400		11.80				208
450		13.30				234
500		14.80				260



Head of Double Bucket Elevator

Double Bucket Elevator Type BWZ-D

Higher kiln capacities and consequently new grinding processes in the cement industry require Bucket Elevators with conveying capacities of more than 2,200 m³/h.

AUMUND meets these latest requirements with the Double Bucket Elevator Type BWZ-D. By combining two standard Bucket Elevators with central chain, the conveying capacity can be doubled.

The drive head illustration shows the two bucket strands on a common drive shaft, which is supported in pillow-block bearings. Twin drives are installed in order to provide the high drive power required.

The two bucket strands are arranged in one and the same casing. The chutes in the feeding area direct the material to the bucket strands by way of a material flow divider.

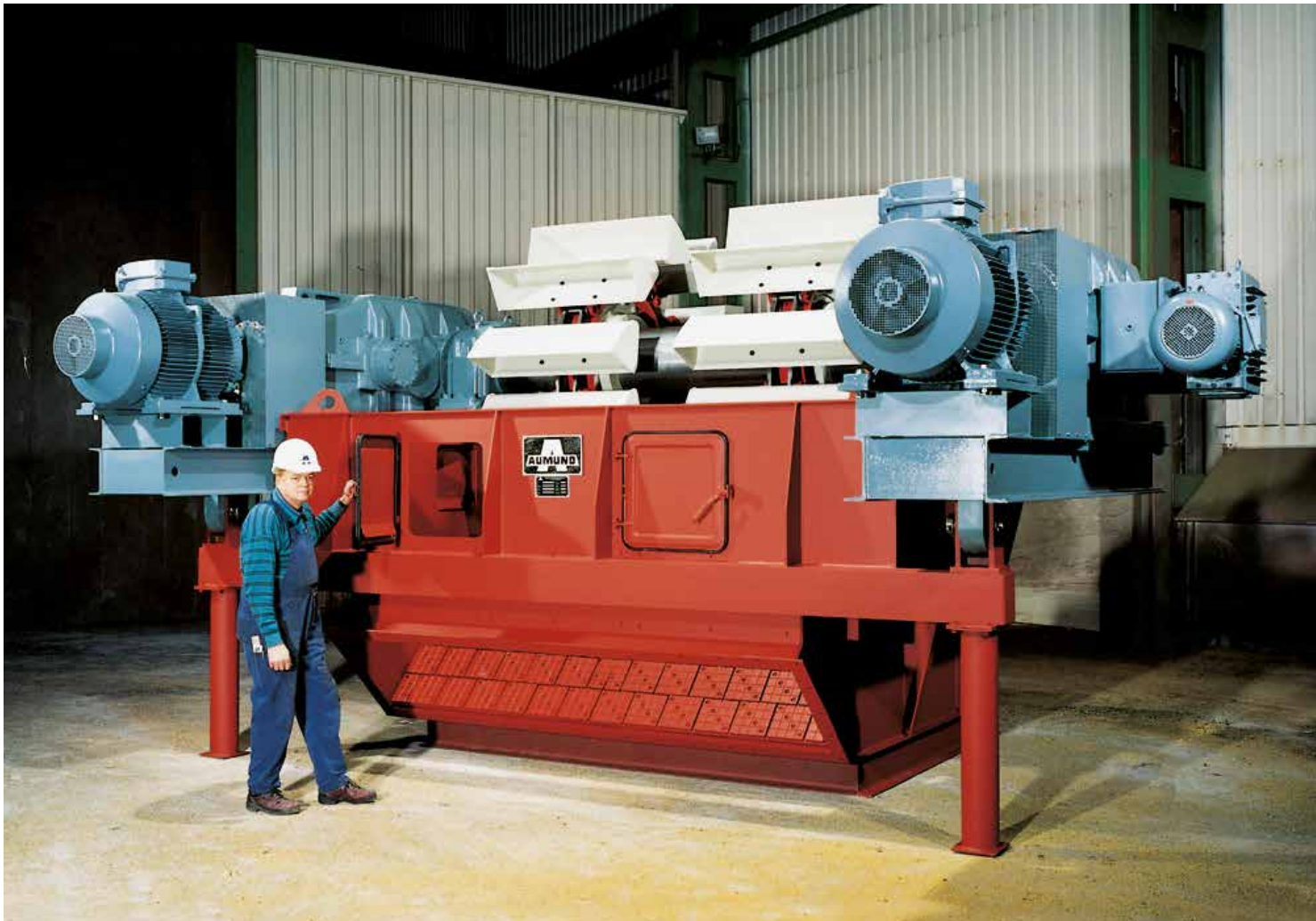

Head with double drive and two strands

Double Bucket Elevator Type BWZ-D – High Performance Elevators

The indicated conveying capacities correspond to a 100% bucket filling (water filling)

Bucket				Drive Ring ϕ [mm]			
Width [mm]	Protrusion [mm]	Volume [dm ³]	Spacing [mm]	790	1,005	1,115	1,215
				Conveying speed (m/s)			
				1.40	1.60	1.77	1.92
				Conveying capacity (m ³ /h)			
400	320	18.80	AU 04	532	610	674	730
450		21.10		598	684	756	820
500		23.50		666	762	842	914
560		26.30		746	852	942	1,022
630		29.60		840	960	1,062	1,152
710		33.40	355.6	946	1,082	1,196	1,298
800		37.60		1,066	1,218	1,348	1,462
900		42.30		1,200	1,372	1,518	1,646
1,000		47.00		1,332	1,522	1,684	1,826
1,100		51.70		1,466	1,676	1,854	2,010
1,200	56.40	1,600	1,828	2,022	2,194		



Belt Bucket Elevators handling raw meal

Belt Bucket Elevator Type BWG

Outstanding features of the AUMUND Belt Bucket Elevators are high lifts and conveying capacities. These high-performance bucket elevators are designed for continuous operation with low maintenance requirements.

All drive pulleys feature exchangeable friction linings. The segments can be easily exchanged without opening the belt.

In the elevator boot a bar-type drum ensures the guided return of the belt. Precise parallel guidance is obtained with the parallel tensioning device.

The bucket design and the close bucket spacing are proven assets allowing continuous material take-up and discharge.

The buckets are fastened to the elevator belt with flat head screws of special design engaging in the longitudinal and cross steel cords. Utmost resistance to tearing is thus guaranteed for the buckets. Rubber strips are fitted between bucket and belt.



Preheater feeding

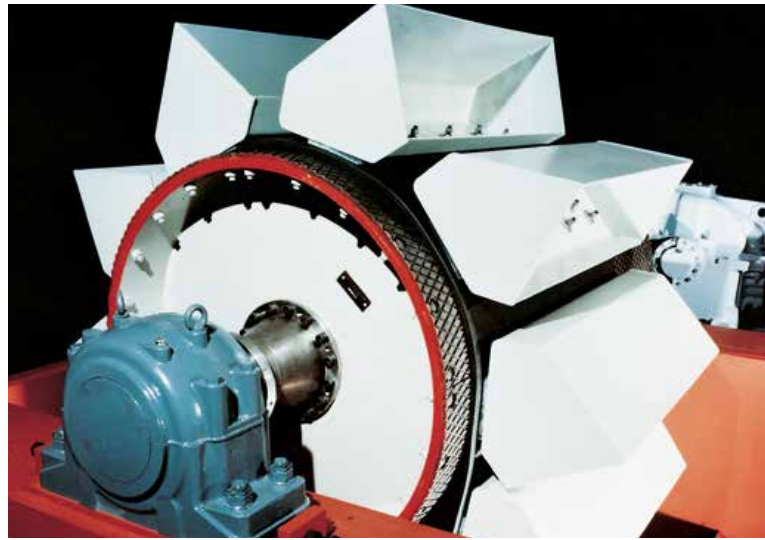

Drive drum with friction lining



Bucket strand with close bucket spacing

Characteristic features of AUMUND Belt Bucket Elevators

- Lifting heights to 175 m
- Conveying capacities exceeding 2,300 m³/h
- Accepting permanent bulk material temperatures to 130 °C
- Continuous material take-up and discharge due to the close bucket spacing
- Straight running belt
- Compact buckets with close spacing
- High tensile strength of the steel-reinforced belts with longitudinal and cross ropes
- Segmented friction linings on all drive pulleys
- Assembly casing with large doors and easy access
- Outstanding service life in continuous operation
- High degree of availability



Elevator boot with parallel tensioning device

Steel-reinforced belt

With their low thickness, the belts allow to use smaller pulley diameters. Depending on the strength class, longitudinal ropes with a diameter of 3.1 up to 5.4 mm and arranged at a distance of 4.75 to 8.8 mm are applied as traction elements. Together with the additional cross ropes, they form a rigid network structure ensuring the high resistance to tearing of the bucket fixation screws. Depending on the strength class, the cross ropes are either provided on one or on both sides.

Belt splicing

Belt splicing is made by clamping the steel ropes in a casting compound box. The rope ends are connected by means of clamps and then cast with a special casting compound. This ensures reliable splicing with no chance for the belt ends to escape

Belt Bucket Elevator Type BWG – High Performance Elevators

The indicated conveying capacities correspond to a 100% bucket filling (water filling)

Bucket

Width [mm]	Protrusion [mm]	Volume [dm ³]	Spacing [mm]	Drive drum [ø mm*]	Speed [m/s]	Max. Capacity [m ³ /h] 100 %
400	350	26.7	390	1,038	1.57	387
500		33.4				484
630		42.1				610
630	370	47.0	410	1,163	1.76	726
800		59.7				923
1,000		74.4				1,150
800	415	75.4	455	1,288	1.94	1,157
1,250	370	93.0	410	1,163	1.76	1,437
1,000	415	94.3	455	1,288	1.94	1,447
1,250		118.0				1,811
1,400		132.2				2,029
1,600		151.0				2,318

* with friction lining

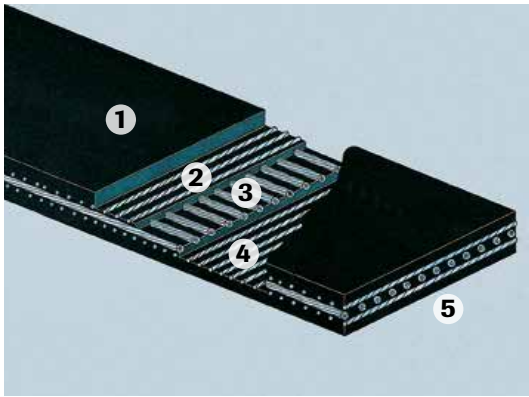

Belt construction

- 1 Upper cover – carrying side
- 2 Upper cross rope
- 3 Longitudinal rope (traction element)
- 4 Bottom cross rope
- 5 Bottom cover – backing

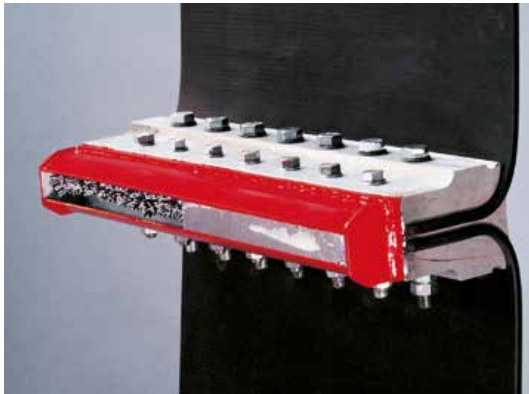

Belt splicing

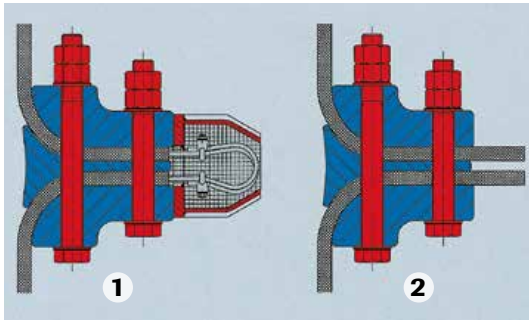

Belt clamp connection

- 1 Steel-reinforced belt
- 2 Textile belt



Bucket Elevator for low to medium capacities

Low to medium capacity Belt Bucket Elevators

Same as the Central Chain Bucket Elevator, the Belt Bucket Elevator is available for smaller capacities either with the steel-reinforced belt or with a textile belt.

Belt Bucket Elevator Type BWG – Low to Medium Duty

The indicated conveying capacities correspond to a 100% bucket filling (water filling)

Bucket

Width	Protrusion	Volume	Spacing	Drive drum	Speed	Max. Capacity
[mm]	[mm]	[dm ³]	[m/s]	[ø mm*]	[m ³ /h]	[m ³ /h] 100 %
250	250	8.4	290	664	1.34	140
315		10.6				176
355		12.0				200
400		13.5				225
450		15.2				253
500		16.9				281

* with friction lining



Splicing of steel-reinforced belt

Conversions and Refurbishments

- Upgrading of existing plant components
- Targeting increased efficiency
- Higher output
- Improved availability

With our expert team of engineers planning selective modernisation measures, we pay special attention to the upgrading of existing plant components, targeting increased efficiency, higher output rates and improved availability.

Upgrading of your materials handling and storage equipment to state-of-the-art technology is achieved through a tailor-made refurbishment process under optimum utilisation of time and budget.

Most of the existing components are re-used in the refurbishment process to save cost.

Engineered conversions and refurbishments for increased efficiency and output are performed on AUMUND equipment as well as on the equipment of other manufacturers.

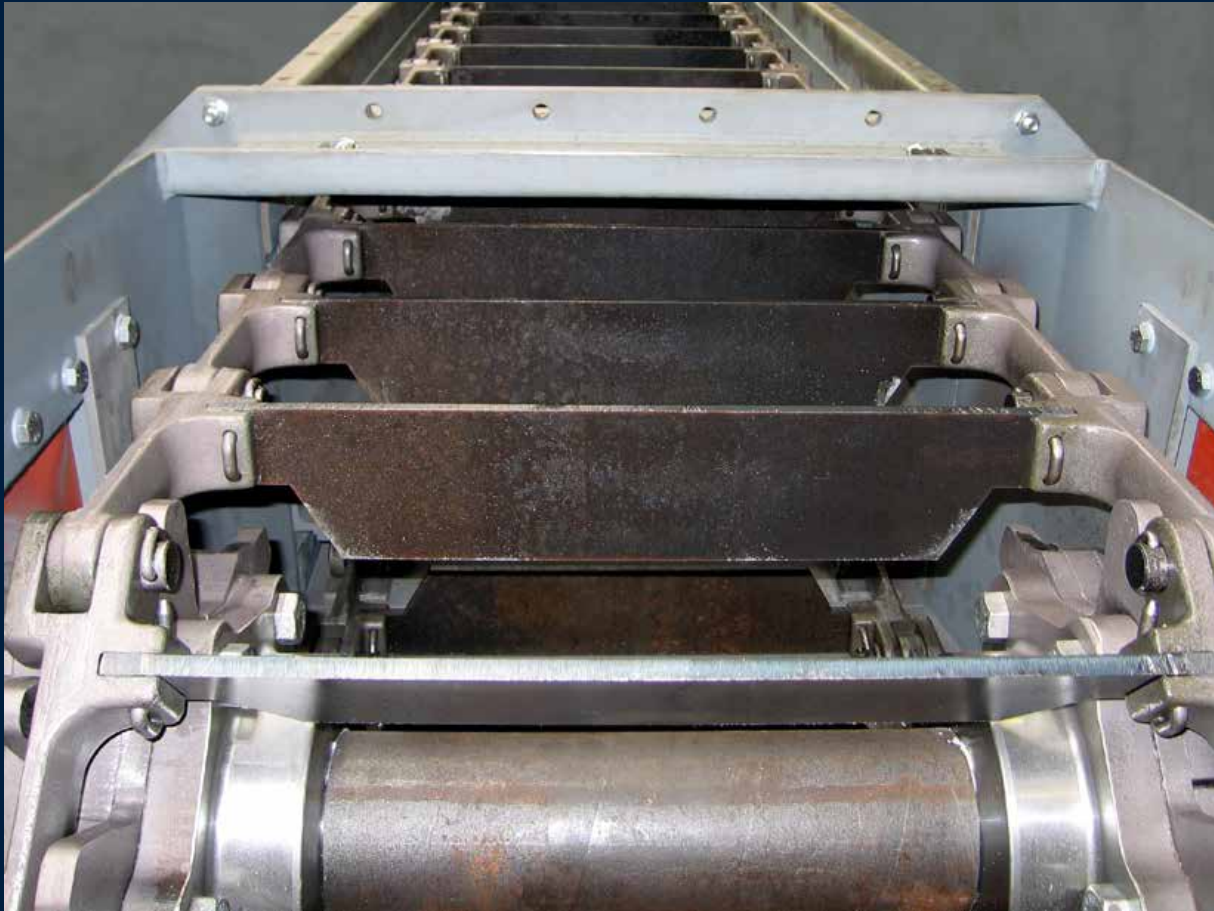

Chain Conveyors

CONTENT

2	Chain Conveyors Type LOUISE TKF
4	Selection of Trough Sections
6	Applications
8	Coal Mill Feeding
9	Chain Conveyor with Gravity Chain Tensioning
10	Waste Incineration Plants
12	Components & Details
14	Conveying Capacity
15	After Sales Service

Chain Conveyors type LOUISE TKF

For conveying, distributing, and reclaiming powdery, coarse, fine grained, abrasive and moist bulk materials such as:

- Natural and FGD Gypsum
- Blast furnace slag
- Limestone
- Burnt lime
- Clinker
- Raw meal
- Cement
- Filter dust
- Coal
- Ash
- Fertilizers
- Soda ash

Designed to suit the properties of the bulk material, the operating hour and the conditions of the surroundings, with the appropriate chain speed and chain width being of vital importance for the service life of the conveyor.

- Dust tight design
- No spillage
- Centre distance to 50 m
- Design with single or double-strand chain
- Available in shock pressure proof design
- Low maintenance
- Long service life



Filter dust reclaim

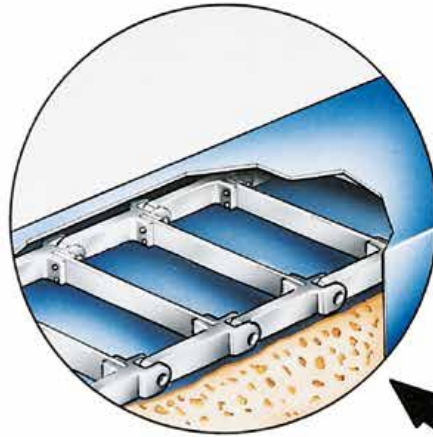

Selection of Trough Sections

Available with single and double-strand chain depending on the application

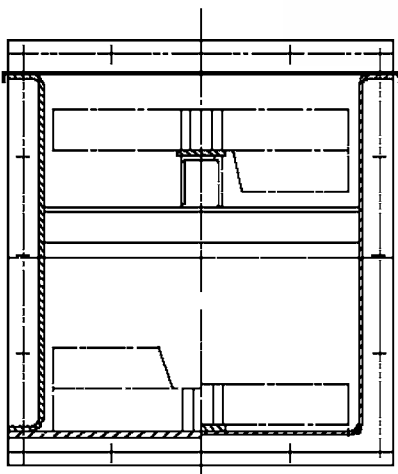
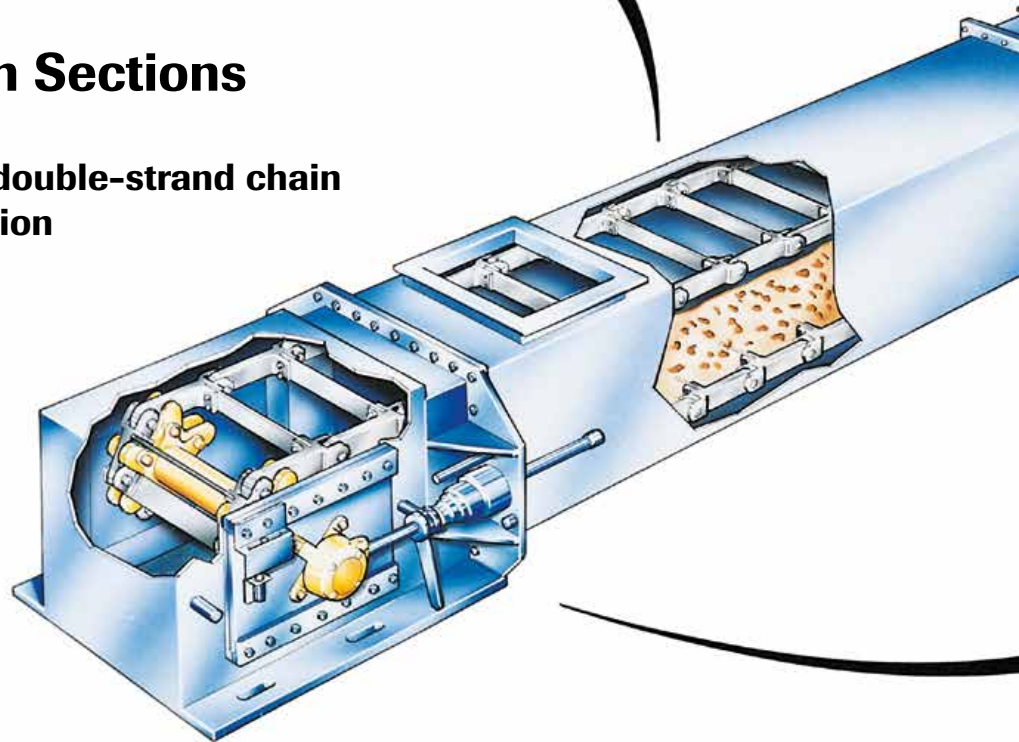

Single-strand chain with standard/oversized flights

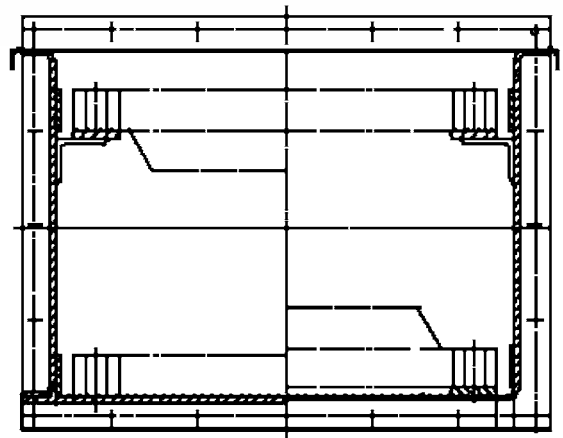

Double-strand chain with wear plates

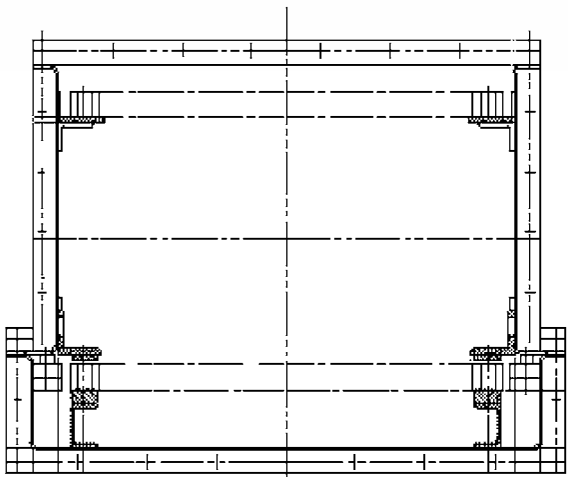
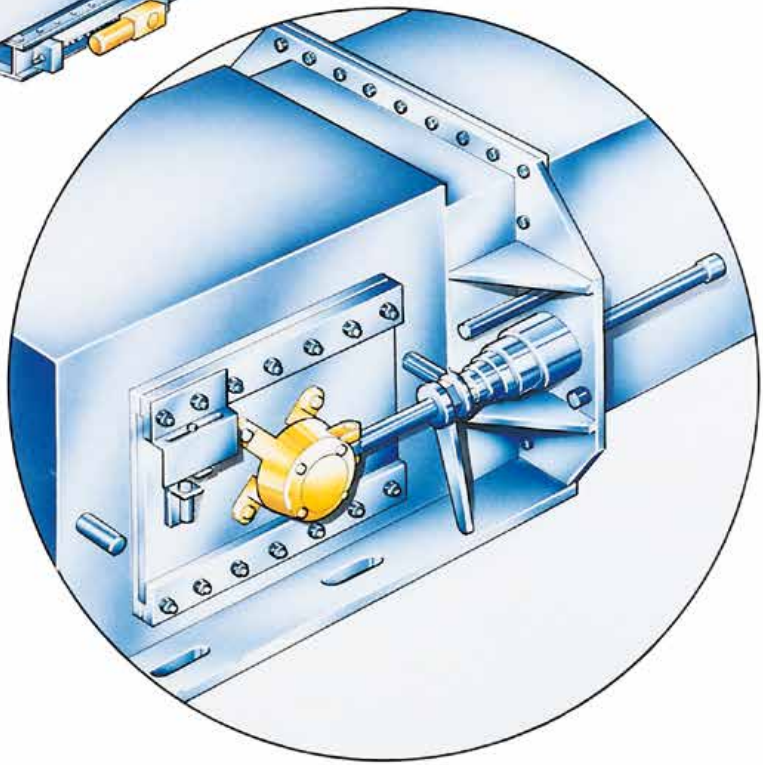
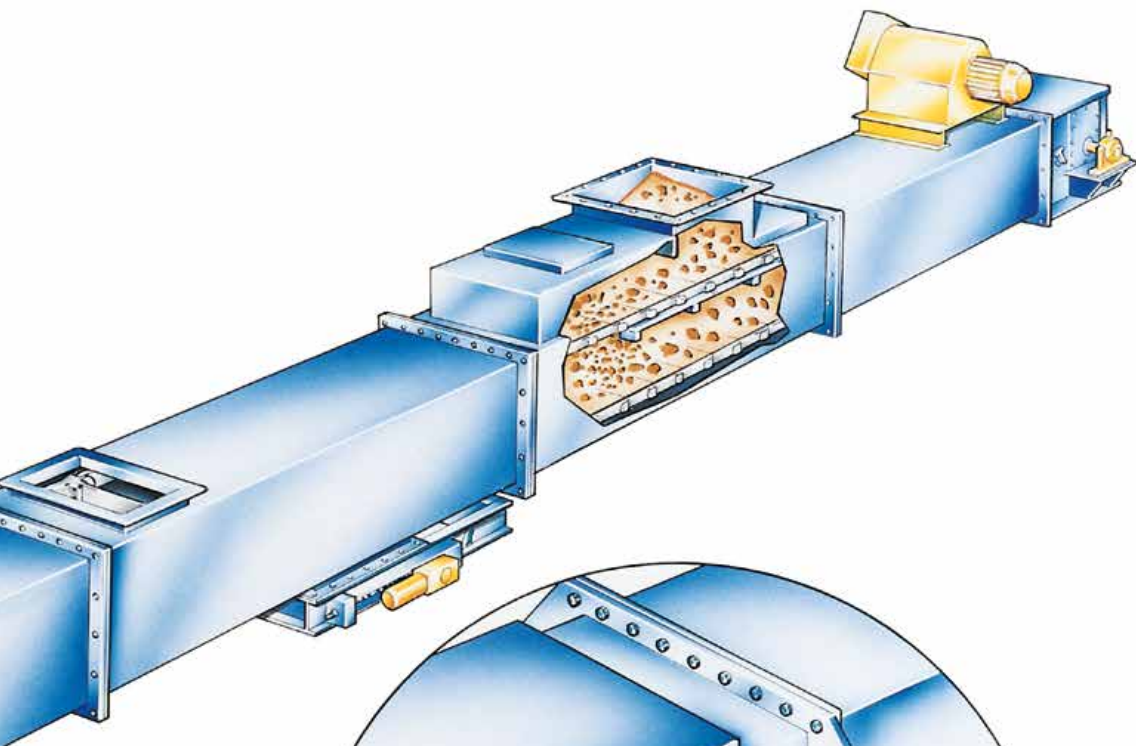

Section with material bed for clinker transport

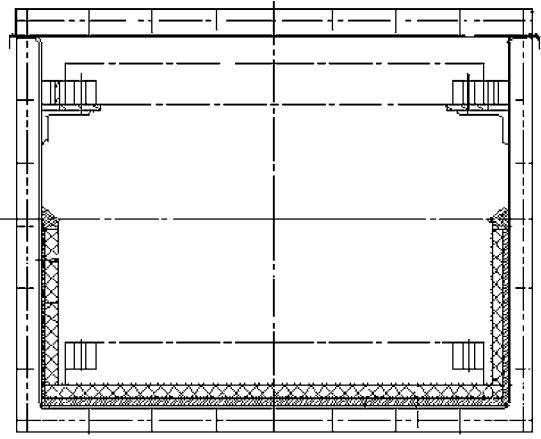

Section with cast basalt lining

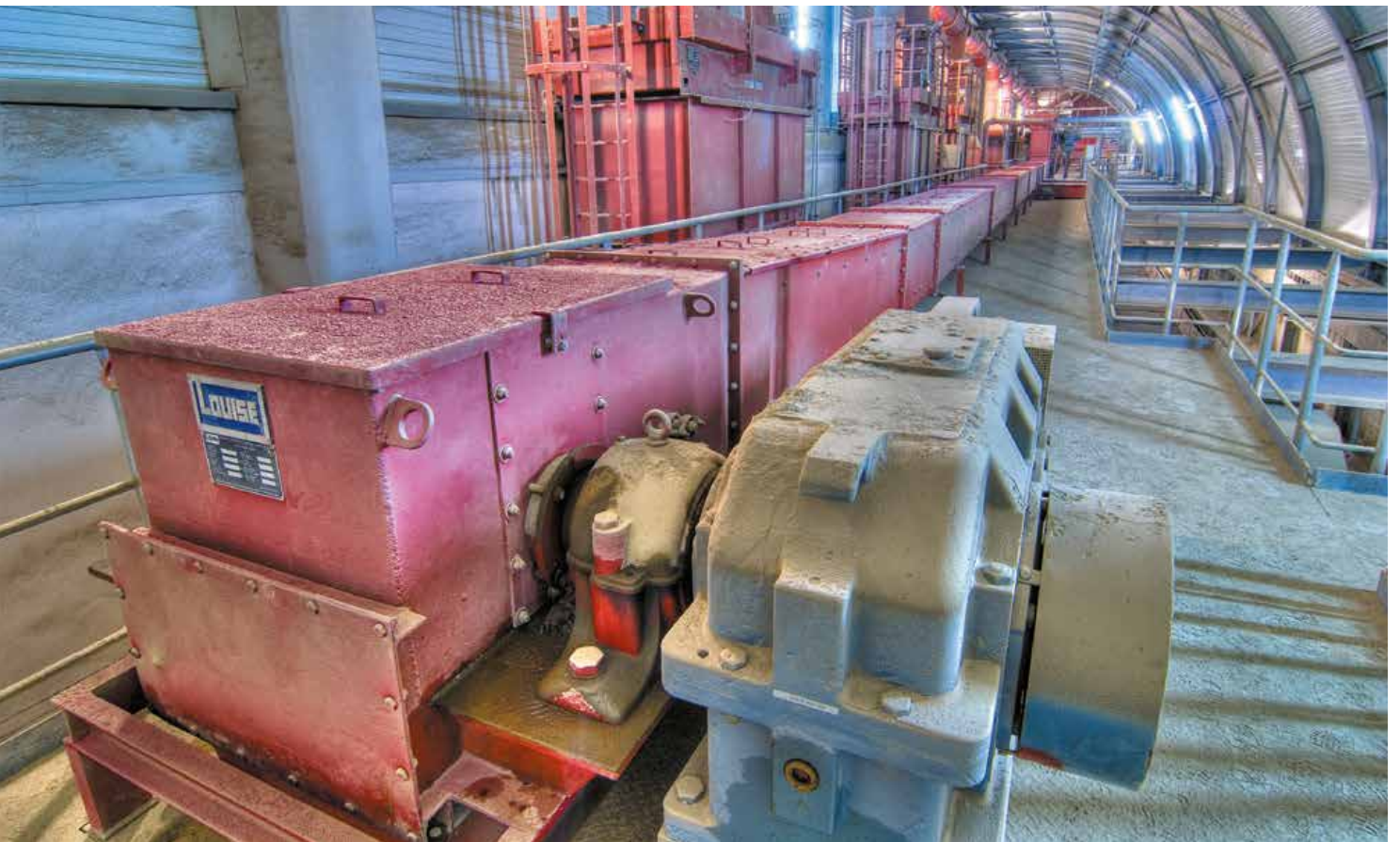

Distributing bulk materials into a battery of silos

Applications

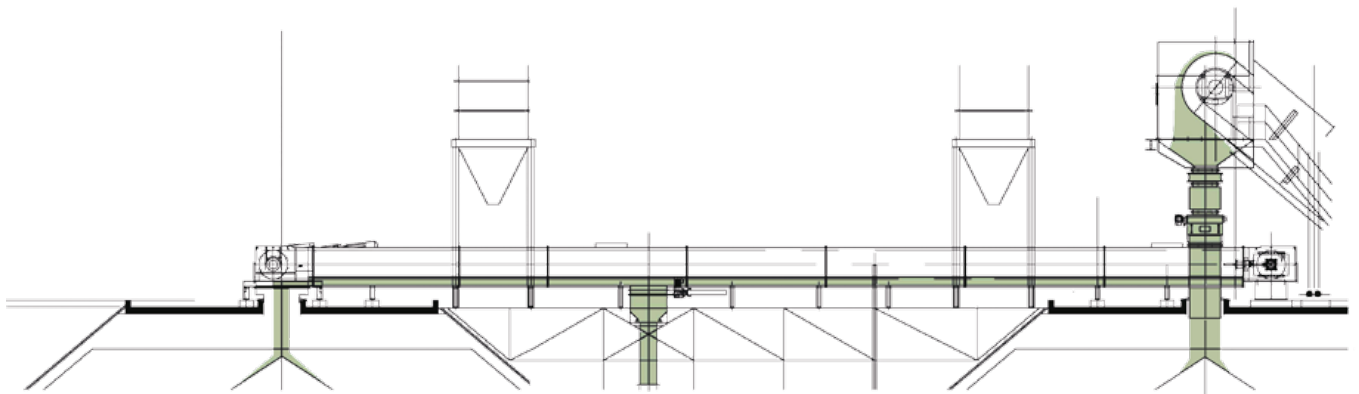

Distribution of various types of bulk materials

Chain Conveyors to convey and distribute bulk materials to different locations.

Controlled feeding of the Chain Conveyor is realized through one single feeding chute. The number of discharge openings varies in accordance with the plant requirements. All intermediate discharge openings are fitted with remote controlled shut-off gates allowing to choose the receiving silo from the central control room. The final discharge opening in the drive station remains open at any time.

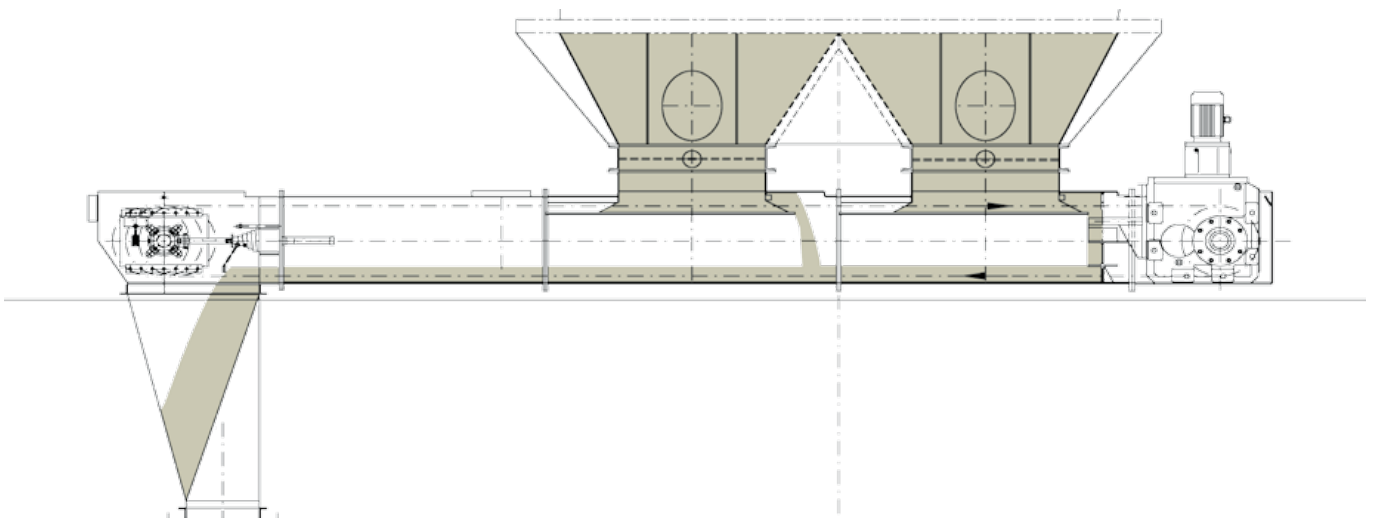

Reclaim of bulk material from various silos or hoppers

A double row needle gate or a motorized slide gate, open in normal operation, isolates the silo or hopper from the Chain Conveyor for maintenance purposes. During the discharge process the full load of the bulk material is supported by a discharge table located underneath the reclaim opening on the return run.

This arrangement enables the volumetric discharge at the required rate by regulating the height of the material layer either with the chain speed through the frequency converter or with a motorized or manual level control. Discharge onto subsequent equipment is realized through the discharge opening in the tension station.

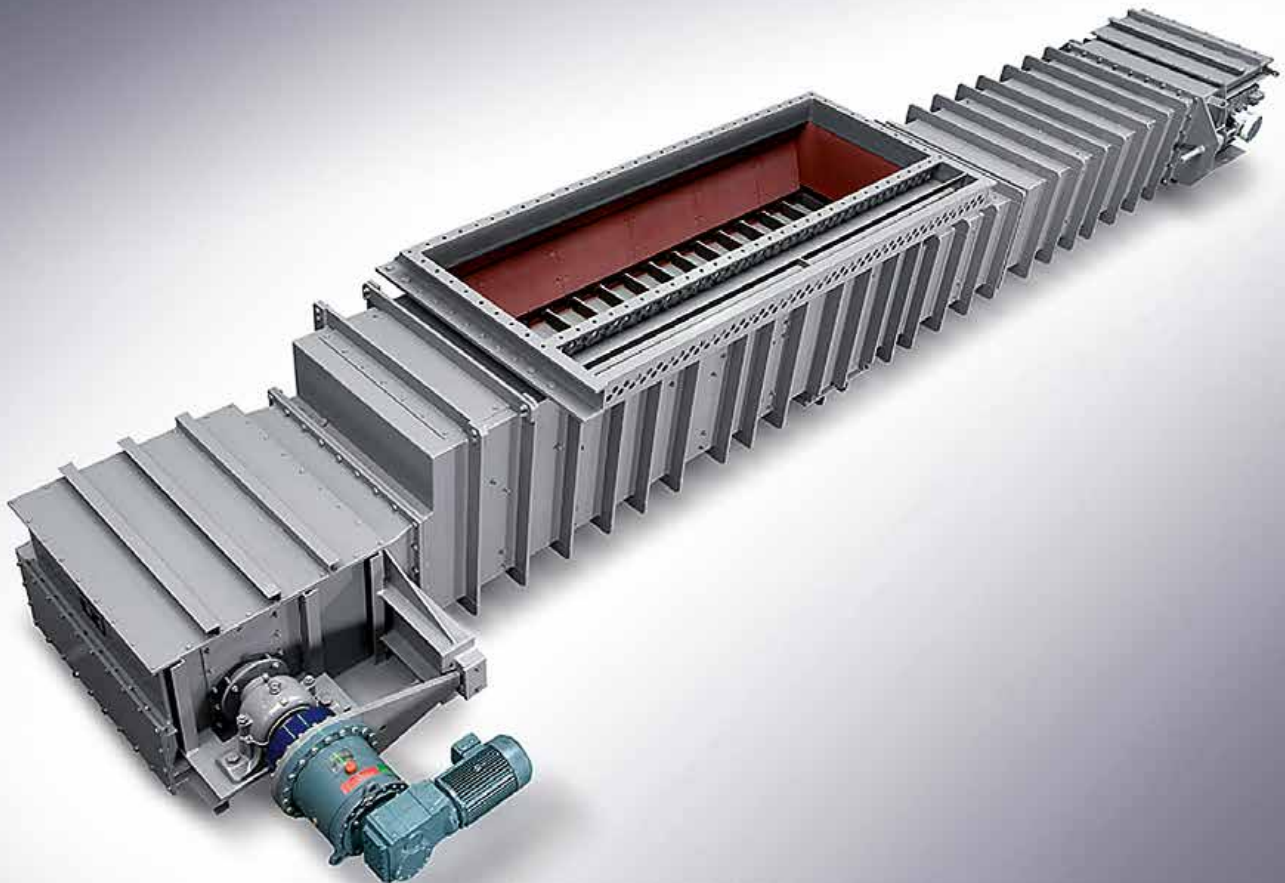

Coal Mill Feeding

For coal mill feeding applications, all Chain Conveyors come in a shock-pressure proof design resisting to 3.5 bar on a standard basis.

These Chain Conveyors feature a double-strand chain. A variable speed drive with frequency converter ensures a uniform material flow and controlled feeding.



Chain Conveyor with Gravity Chain Tensioning

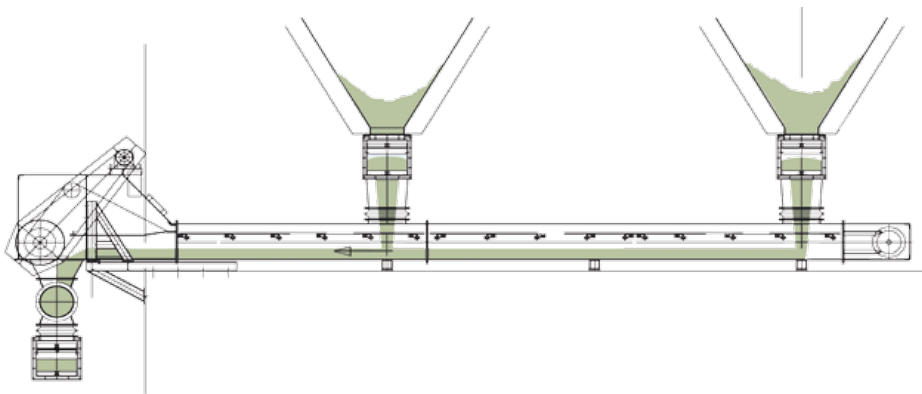

For the reclaim of fines such as precipitator dust from filter hoppers, the Chain Conveyor with gravity chain tensioning is an economic solution as an integrated or add-on conveyor.

Chain tensioning is achieved by guiding the chain over an idler roller in the drive station, thus causing the chain to sag by its own weight, ensuring perfect fit of the chain around the chain sprocket. With this conveyor design, no tensioning device is required in the return station.

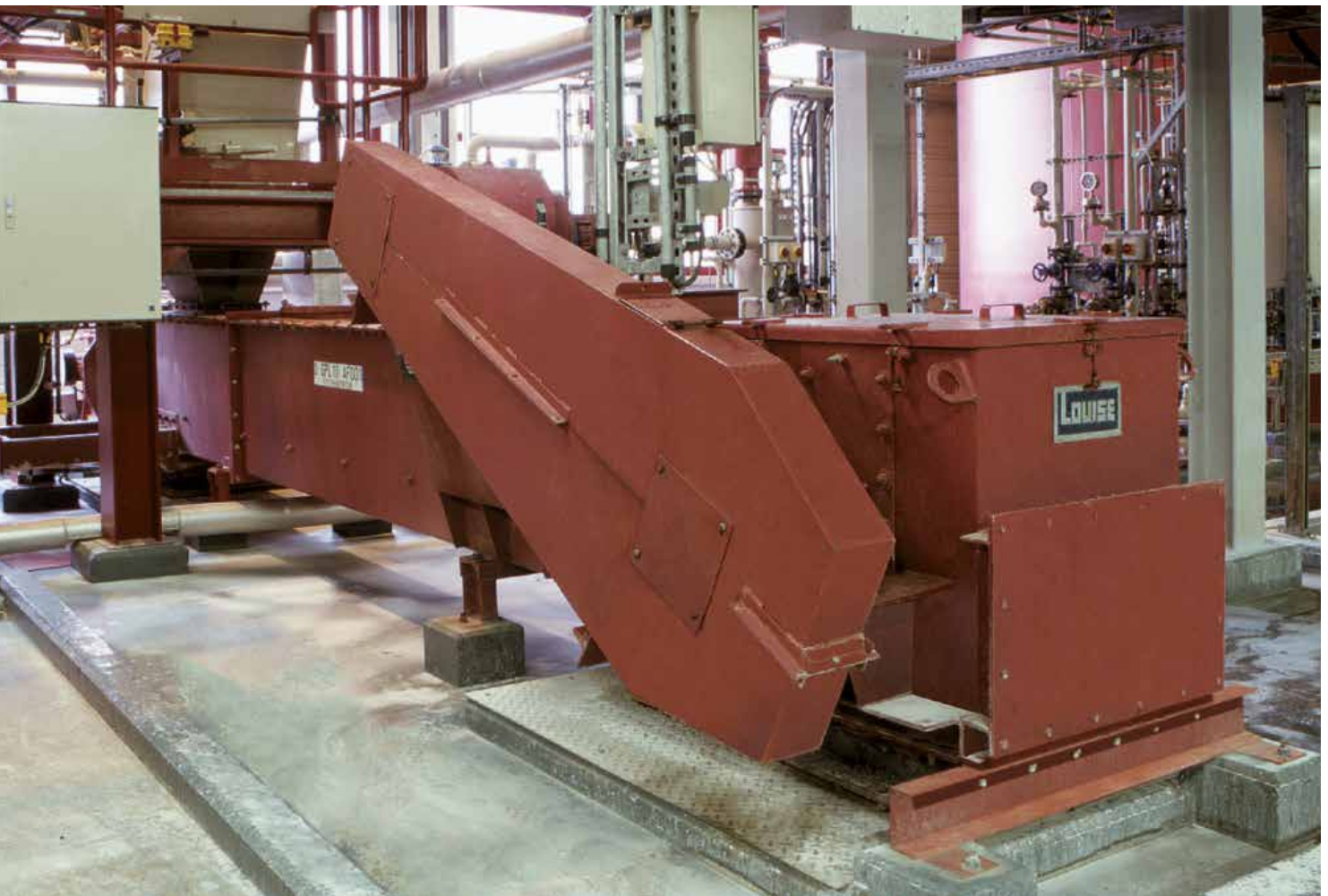

A double-strand Chain Conveyor loads FGD Gypsum from the flue-gas desulphurisation into the storage silo

Waste Incineration Plants



Hot boiler ash from a row of boilers

Proportional feeding of the Chain Conveyor handling the boiler ash allows for homogeneous distribution of the 200 - 550 °C ash in the conveyor trough.

The dust taken from the precipitator has a temperature of approx. 300 °C.

Both Chain Conveyors are equipped with a single-strand chain.

Bottom ash and filter dust are unloaded into intermediate storage silos.



Limestone handling



View into Chain Conveyor - Limestone feeding

Components & Details

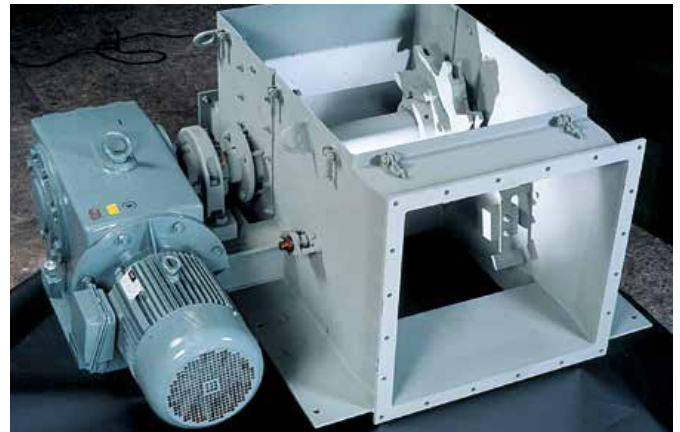
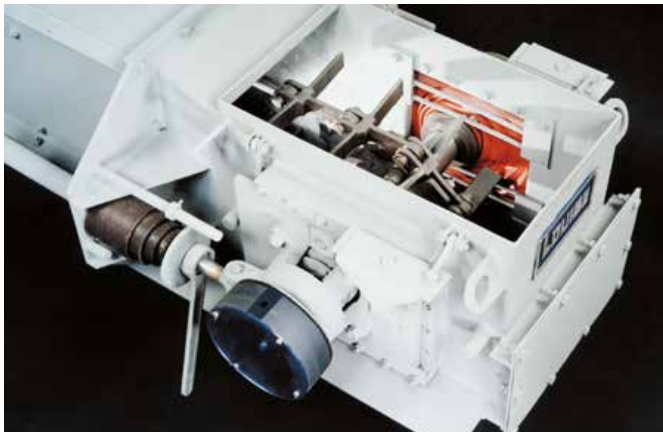

Tension Station

Drive Station

- 1 Chain tensioning device
- 2 Return sprocket
- 3-4 Tension bearing
- 5 Hub
- 6 Stuffing boxes
- 7 Speed monitor
- 8 Bearing shield end position
- 9 Chain monitoring
- 10 Reference point for pretension
- 11 Station cover

- 1 Drive sprocket
- 2 Stuffing box
- 3 Pillow block bearing
- 4 Pillow block bearing support
- 5 Outlet flange
- 6 Chain scraper
- 7 Maintenance opening
- 8 Station cover

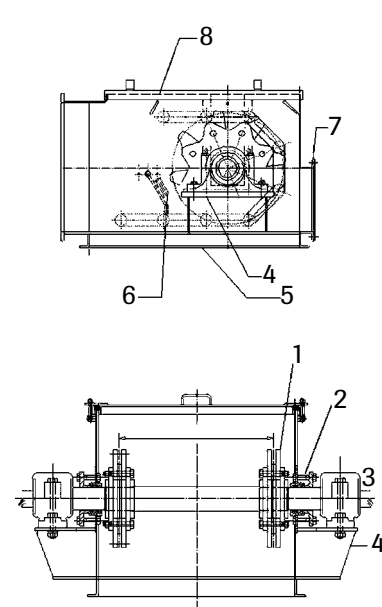
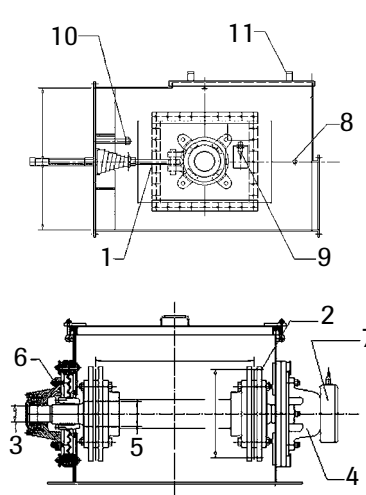

Fork Link Chains

LOUISE single and double-strand chains are drop-forged and extremely wear-resistant.

Chain links and connecting pins are hardened to 58–60 HRC.

The flights are either welded to the chain links for single-strand chains or fixed with fastening bows on both sides of the chain links for double-strand chains.

The steel used for fabrication of the flights is chosen to suit the bulk material's properties. If abrasive material is to be conveyed, the flights are fabricated from wear-resistant steel.

Standard widths of single-strand chains range from 250 mm to 630 mm. Standard double-strand chains range from 630 mm to 2,000 mm.

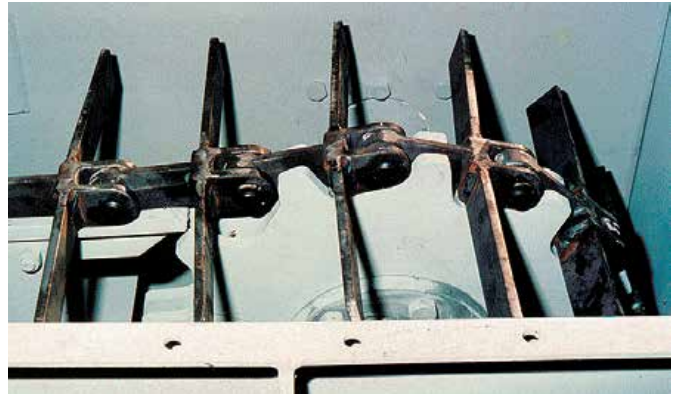

Single-strand chain



Double-strand chain

Chain Sprockets

The chain sprockets are hardened in areas subject to wear. The sprockets are split into segments as a standard. Therefore, replacement of the sprocket sections does not imply disassembly of the chain strand.

Depending on the load, the sprockets feature six, eight, ten or twelve teeth.



Drive sprocket



Take-up sprocket

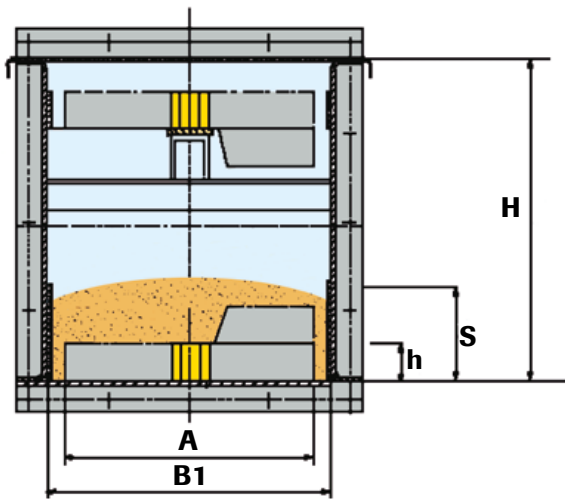

Single-strand chain

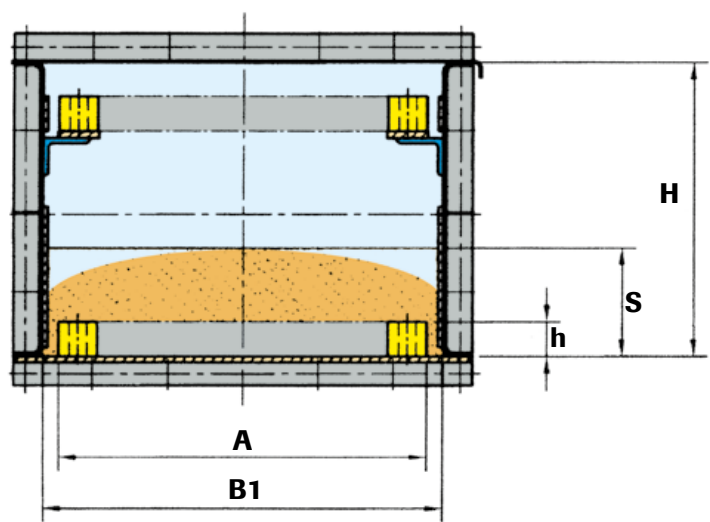

Double-strand chain

Conveying Capacity

The properties of the bulk material are essential to determine the main features of the Chain Conveyor's components such as chain type or flight height. They

also determine the material layer and the actual conveying capacity. The following capacities are based on standard conditions.

Conveying capacity with standard conditions

Width A	Trough		Material level S	Flight Height h	Theoretical capacity m ³ /h					
	Width B1	Height H*			<i>Conveying speed m/s</i>					
mm	mm	mm	mm	mm	0.05	0.10	0.15	0.20	0.25	0.30
250/1	306	515	100	50	5.5	11.0	16.5	22.0	27.5	33.0
400/1	456	515	150	50	12.5	25.0	37.5	50.0	62.5	75.0
		645		50						
630/1	686	515	170	50	20.0	40.0	60.0	80.0	100.0	120.0
630/2		645		50						
800/2	856	515	200	50	29.5	59.0	88.5	118.0	147.5	
		645	230	60	34.5	69.0	103.0	138.0	172.5	
1,000/2	1,056	645	230	60	49.5	99.0	148.5	198.0	247.5	
		775	280	60	51.5	103.0	154.5	206.0	257.5	
1,200/2	1,256	645	230	60	50.5	101.0	151.5	202.0	310.0	
		775	280	60	62.0	124.0	186.0	248.0		
1,400/2	1,456	645	230	60	59.0	118.0	177.0	236.0		
		775	280	60	71.5	143.0	214.5	286.0		
1,600/2	1,656	775	280	80	81.5	163.0	244.5	326.0		
1,800/2	1,856	775	280	80	91.5	183.0	274.5			
2,000/2	2,056	775	280	80	102.0	204.0	306.0			

* The trough height depends on the chain size and the number of sprocket teeth.



Clinker Storage Systems

CONTENT

2	Clinker Storage Systems
3	Circular Storage Hall without Central Column
4	Cylindrical Concrete or Steel Silos
6	Covered Stockpile with Central Column
7	Covered Stockpile with MOLEX®
8	Storage Hall with Earth Cone
9	Clinker Discharge Dust Suppression
10	Conversions and Refurbishments
19	After Sales Service

Clinker Storage Systems

The AUMUND Group Equipment for the Cement Industry is being applied world-wide in more than 10,000 plants.

Design, implementation and modernisation of clinker storage installations, customised as per requirement, achieve maximum customer benefit.

- Adapted to the customer's specific requirements, all transport processes are constantly optimised based on innovations and the latest technical know-how.
- Combining economic and ecological aspects including future demands, balanced solutions are considered.
- High safety standards in all functions and under all conditions have been proven world-wide in technology, quality and reliability.

To receive an optimum overall conveying and storage layout, early involvement of AUMUND's experienced layout engineers is recommended.

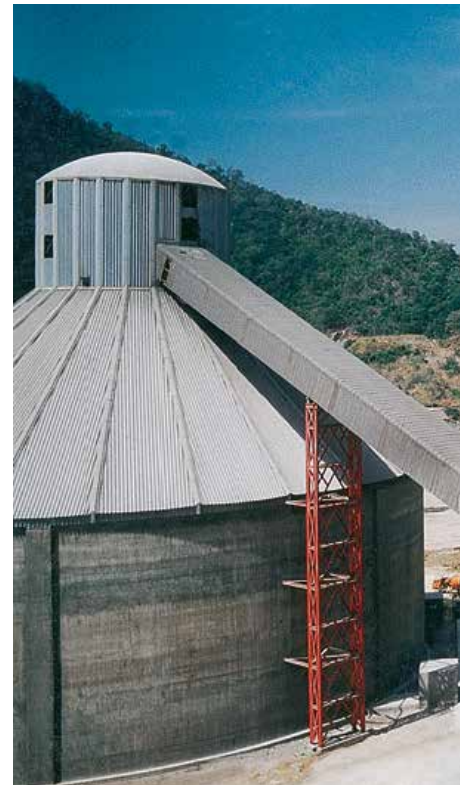

Circular storage hall 150,000 t



Circular storage hall 60,000 t



Circular storage hall 2 x 75,000 t

Circular Storage Hall without Central Column

Storing capacity from 50,000 to 250,000 t

These circular storage halls consist of a pretensioned reinforced concrete cylinder with a diameter of 40 to 80 m and a height from 10 to 25 m. A cone-shaped roof structure is arranged above the concrete cylinder. The roof is a self-supporting steel frame covered with trapezoidal plates. Special sealing elements at the joints of the trapezoidal plates make the roof structure dust-tight. For compensation of thermal stresses, the roof structure is arranged on special sliding bearings which are installed in the upper edge of the concrete cylinder.

The roof structure supports the headhouse with the drive station of the pan conveyor and the filter systems for dedusting of the storage hall. The diameter and height of the headhouse are determined to suit the dimensions of these systems. For all circular storage hall diameters, the main dimensions of the roof structure and headhouse are standardised. The storing capacity of these circular storage halls ranges from 50,000 to 250,000 t. Larger capacities can also be realized. Due to the reduced system height and the large diameter, it is also possible to build these circular storage halls on soils with a low bearing capacity. A minimum of approx. 500 kN/m² is required.

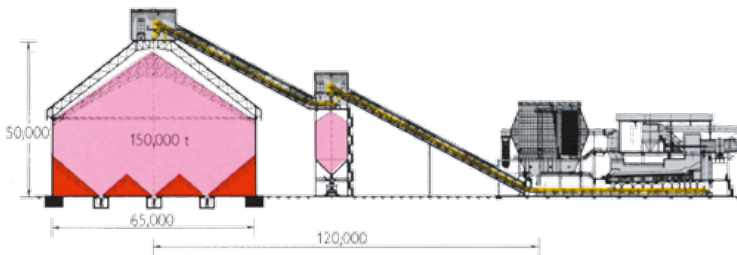

Circular storage hall without central column

D m	H m	h m	Storing capacity t		Discharge rate %
40	15	14.1	34,900	23,250	80
	20	14.1	44,300	29,500	84
45	15	15.8	45,500	30,300	76
	20	15.8	57,400	38,800	80
50	25	15.8	69,300	46,200	84
	15	18.7	57,800	38,500	81
55	20	18.7	72,500	48,300	84
	25	18.7	87,200	58,200	87
60	15	20.5	71,900	47,900	79
	20	20.5	89,700	59,800	82
65	25	20.5	108,000	71,700	85
	15	22.1	88,000	58,700	81
70	20	22.1	109,000	72,800	84
	25	22.1	130,000	86,900	87
75	15	25.0	106,000	70,700	83
	20	25.0	131,000	87,300	86
80	25	25.0	156,000	104,000	89

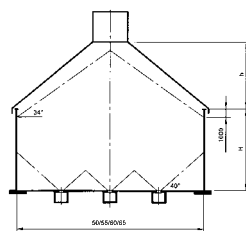
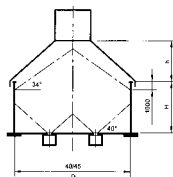

The material is discharged to two to four discharge tunnels, depending on the storage hall diameter. A discharge rate of approx. 85% is achieved.

During the loading process, the clinker segregates and forms cones according to the particle size. A homogenous clinker mixture is, however, an essential condition for the performance of cement mills. Therefore, it is recommended to systematically shift the silo discharge gates in order to blend the different particle sizes in the silo. In addition, regular shifting of the discharge openings ensures that the stored clinker level in the silo lowers uniformly, thus avoiding early discharge of fresh clinker.

Circular storage hall with concrete cylinder and steel roof without central column
Preferred sizes

For total residue discharge, additional evacuation equipment is required.

Storing capacity in t with a bulk density of 1.5 t/m³.



2 x 60,000 t silo

Cylindrical Concrete or Steel Silos

Storing capacity from 30,000 to 60,000 t

These silos are made of reinforced concrete or prefabricated special steel. Due to the comparatively small basis, a high discharge rate of approx. 75 % is reached by means of one discharging conveyor only. This implies that the complete material stored in the silo can be extracted to a large extent by gravity discharge, without using mobile evacuation systems.

After several years, a total residue discharge of the silos should be effected, as the material particles lying on the floor tend to consolidate and form a steep cone. Therefore, it is recommended to equip all silos with lockable entrance doors.

With clinker cooler problems, extremely high clinker temperatures exceeding 400 °C must be expected. For these high temperatures, clinker silos are preferably made of steel; otherwise the choice of steel or concrete depends on economical aspects. In certain regions steel plate silos can be produced at more favourable prices.

In general, the storing capacity of these silos ranges from 30,000 to 60,000 t. The largest cylindrical concrete silo designed by AUMUND has a diameter of 45 m and offers a storing capacity of 80,000 t. In view of the chosen diameter, the roof had to be designed as a self-supporting

steel framed structure with trapezoidal cladding – a design standard which is also applied for the large circular storage halls without a central column.

For automatic silo operation, a reliable level control system is of primary importance. A proven solution is the combination of an electro-mechanical silo pilot system to measure the material level in the silo. Several rope probes monitor the maximum filling level and several rod probes arranged in the area of the loading chute activate the emergency shutdown of the conveyor lines.

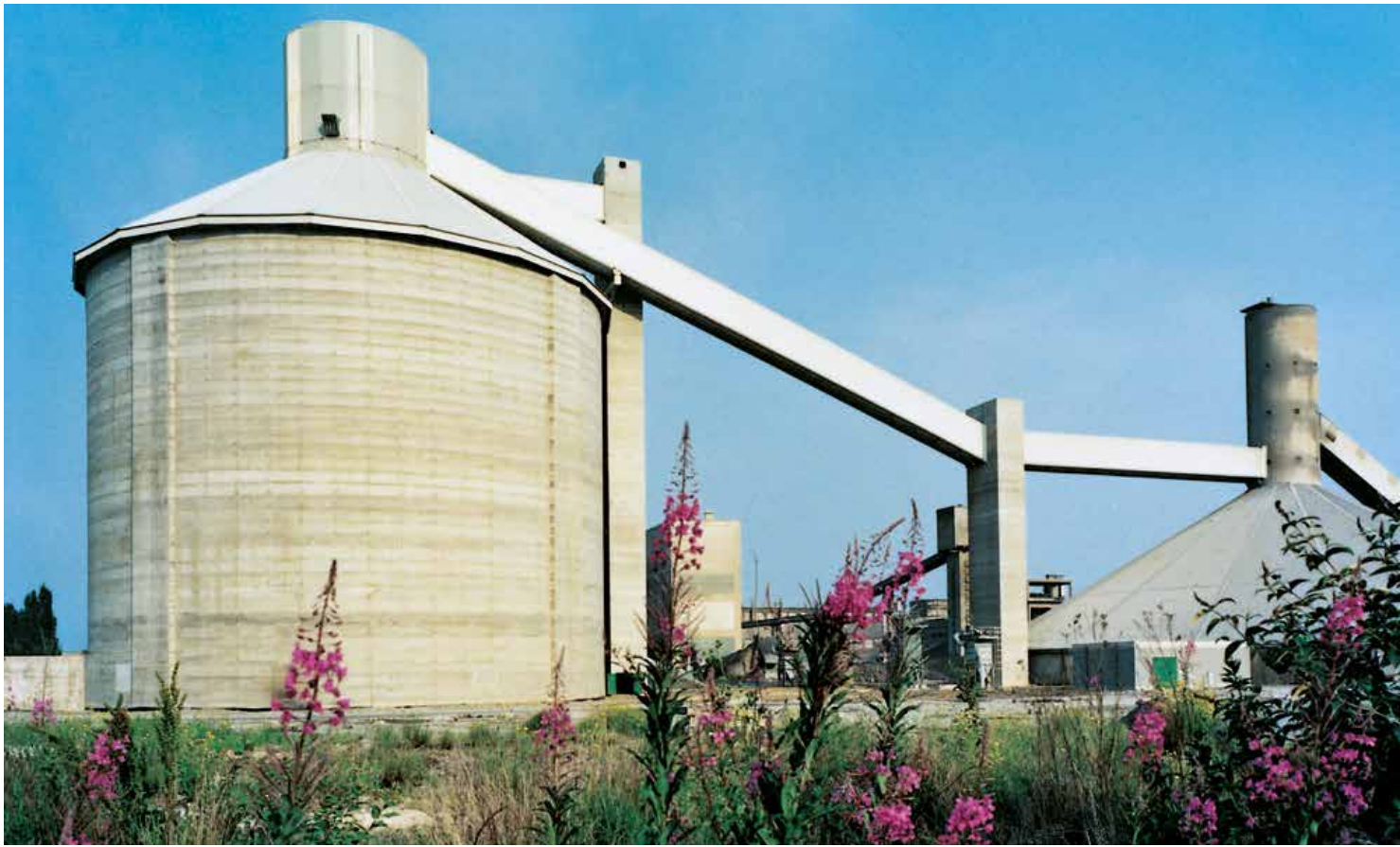

80,000 t silo with steel roof



Silo group for different clinker types

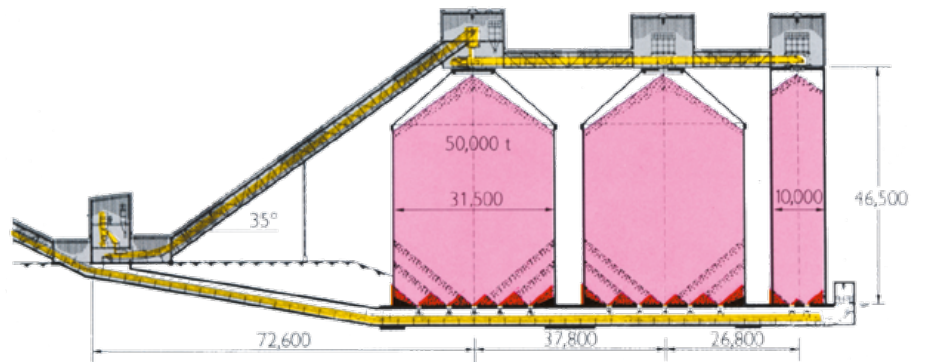

Clinker silos in series



Steel silos, 30,000 t each

D m	H m	h m	Storing capacity		Discharge rate %
			approx. t	m ³	
15.00	18.20	5.10	5,000	3,330	78
17.50	19.80	5.90	7,500	5,000	77
20.00	20.00	6.80	10,000	6,660	74
22.50	23.60	7.60	15,000	10,000	75
25.00	25.30	8.40	20,000	13,330	75
27.50	26.00	9.30	25,000	16,660	73
28.75	28.60	9.70	30,000	20,000	74
30.00	30.60	10.10	35,000	23,330	75
31.50	31.70	10.60	40,000	26,660	75
33.00	32.40	11.10	45,000	30,000	74
34.00	33.90	11.50	50,000	33,330	75
35.00	35.20	11.80	55,000	36,660	75
36.00	36.30	12.10	60,000	40,000	75

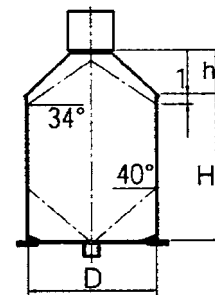

Cylindrical silos
made of concrete
or steel with one
discharge tunnel

Storing capacity
in t with a bulk
density of 1.5 t/m³.



Oval storage hall with internal silos



Circular storage hall with internal silo and earth cone



Covered stockpile with MOLEX®

Covered Stockpile with Central Column

Storing capacity from 50,000 to 190,000 t

The salient features of the covered stockpile with a central column are the low system height and the large diameter. The roof structure covers the material's angle of repose and only a low, circular retaining wall is required.

The central column is provided with slot-shaped outlet openings (stockpile) and supports the simple roof structure, consisting of the steel frame and the trapezoidal cladding. The platform above the central column is designed to receive the conveyor bridge with conveying equipment and the filter system.

A discharge rate of 40 % to 60 % is reached by installing one to three discharge tunnels. For total residue discharge, mobile evacuation systems will be required.

The standard storage diameters range from 70 to 110 m. Storing capacities of 50,000 to 190,000 t can thus be reached.

A special storing facility with a capacity of 230,000 t could be created by combining two storage halls. An essential condition for this project was the load distribution on a surface of 90 m x 126 m. Due to the bad soil with a relatively bad specific soil bearing capacity, special measures were required in order to avoid damage from differential settlement. The bridge structure was thus supported on special bearings and the roof fitted with a jacking system for repeated adjustment.

The two central columns with a diameter of 12 m provide a storing capacity of 4,500 t special clinker each. The storage hall is equipped with three discharge tunnels, ensuring a discharge rate of approx. 60 %.

The large roof surface of this storage hall offers another advantage: the cooling effect on the stored clinker.

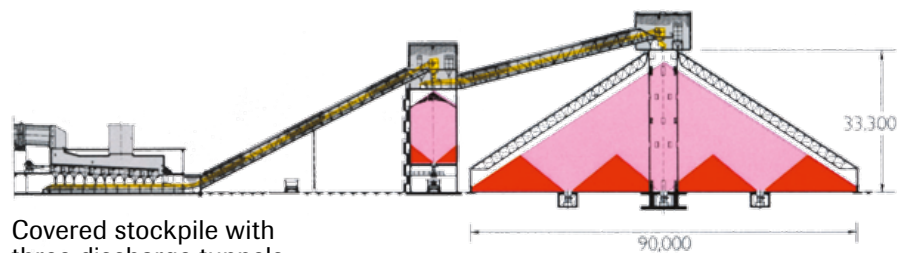

Covered stockpile with three discharge tunnels

D m	H m	Storing capacity t	m ³
70	26.6	51,200	34,100
80	30.0	75,300	50,200
90	33.3	106,100	70,700
100	36.7	144,200	96,100
110	40.1	190,500	127,000

Discharge rate approx. 60 %. For total residue discharge, auxiliary equipment.

Preferred sizes			
70	26.6	48,300	32,200
80	30.0	71,700	47,800
90	33.3	101,600	67,700
100	36.7	138,800	92,500
110	40.1	184,200	122,800

Discharge rate 100 %

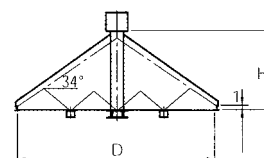

Covered stockpile with three discharge tunnels

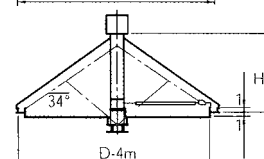

Covered stockpile with mole

In case of irregular filling, a reduced output factor of 0.9 will have to be considered.
Storing capacity in t, with a bulk density of 1.5 t/m³.



MOLEX® with central column



MOLEX® without central column

Covered Stockpile with MOLEX®

Total and automatic residue discharge

The actual live capacity secured with gravity discharge only amounts to a maximum of 85 %, presuming an optimum geometry of the storage facility. The discharge rate of covered stockpiles, although equipped with several reclaim tunnels, is even less.

Total and automatic residue discharge of this storage type is achieved with the automatic discharge system MOLEX® and just one discharge tunnel.

The MOLEX® mainly consists of a scraper chain installed in a bridge structure either turning around the central column or, if the stock is built without a central column, on a support base above the central discharge. The scraper chain drags the clinker which cannot be discharged by gravity to the central discharge hopper. PLC controlled drive systems drive the radial movement of the bridge truss and the scraper chain.

The opposite sketches explain the working principle of the total residue discharge system. The clinker is first discharged by gravity through the central discharge and additional openings in the reclaim tunnel. A level sensor installed in the central hopper monitors the lack of clinker and activates the scraper chain of the MOLEX®. When the scraper blades have cleared the clinker piled against the bridge truss, the travel units for radial movement of the MOLEX® are started.

The power absorbed at the scraper chain drive controls the radial travel movement of the MOLEX® and allows clearing the stock without manual intervention being required.

A further positive aspect complementing the automatic residue discharge is the blending of coarse and fine-grained clinker particles obtained when operating the storage with the MOLEX®, thus allowing the grinding mill to be fed with an almost consistent mixture.



Internal ring with thrust bearings and travel unit



Scraper chain drive



Covered stockpile with MOLEX® and central column



Covered stockpile with MOLEX® without central column

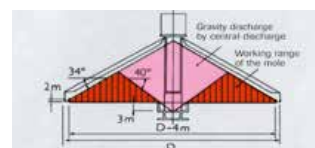

Working range of the MOLEX®

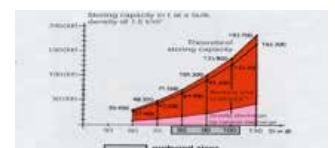

Storing capacity depending on the storage diameter



Clinker storage hall with earth cone

Storage Hall with Earth Cone

Essential increase of storing capacity

The storing capacity of longitudinal and circular clinker storage halls can be essentially increased by the installation of an earth cone. In addition, the discharge rate is considerably improved by this measure. The earth cone is usually provided with an inclination of 40° to 45° . Untreated surfaces simply blasted out of the rock did not prove to be reliable in practice. Despite a low groundwater level, it has to be considered that surface water may penetrate into the earth cone through fissures and gaps. Therefore, the surface of the cone has to be covered with a concrete or steel shell. It is also recommended to install a drainage system in order to ensure that water accumulations can flow off.

For the roof and headhouse, a steel frame with trapezoidal cladding is preferred, as for circular storage halls without a central column.

Clinker discharge from the earth cone is effected through central discharge openings. For safety reasons, at least three silo discharge devices should be provided. These clinker storage halls can also be equipped with a central column, which is then used for storing special clinker. A rotating feed chute is required for feeding the central tower as well as for the symmetrical feeding of the main storage hall.

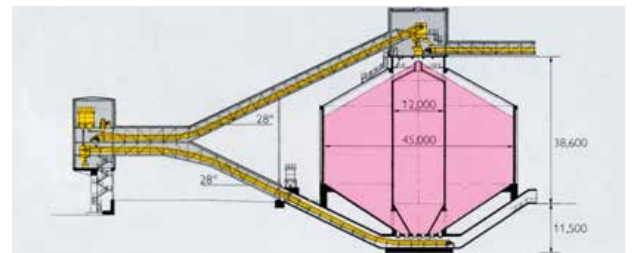

Circular storage hall with internal silo and earth cone

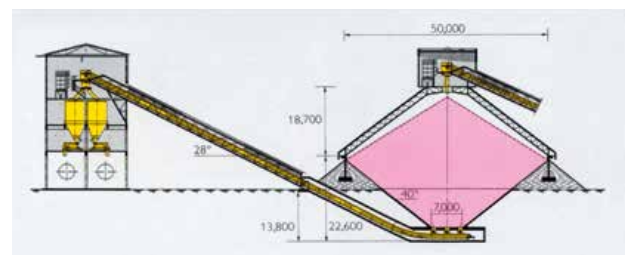

Circular storage hall with earth cone and without central column

D m	H m	h m	T m	Storing capacity	
				t	m ³
40	15	14.1	13.8	45,350	30,200
	20	14.1	13.8	54,750	36,500
45	15	15.8	15.9	60,400	40,300
	20	15.8	15.9	72,350	48,250
50	25	15.8	15.9	84,300	56,200
	15	18.7	18.0	78,300	52,200
50	20	18.7	18.0	93,050	62,050
	25	18.7	18.0	107,800	71,850
55	15	20.5	20.1	99,300	66,200
	20	20.5	20.1	117,100	78,100
55	25	20.5	20.1	134,900	89,950
	15	22.1	22.2	123,500	82,350
60	20	22.1	22.2	144,700	96,500
	25	22.1	22.2	165,900	110,600
65	15	25.0	24.3	151,250	100,850
	20	25.0	24.3	176,150	117,400
65	25	25.0	24.3	201,000	134,000

Circular storage hall with concrete cylinder, earth cone and steel roof without central column

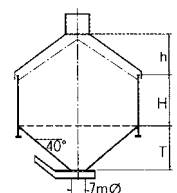

Discharge rate approx. 95 %

Preferred sizes

Storing capacity at a bulk weight of 1.5 t/m^3 .



Silo discharge by remote control – discharge capacity 750 t/h

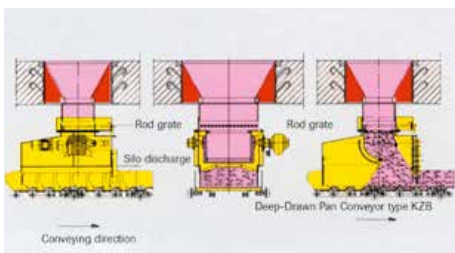

Silo discharge according to the principle of gravity

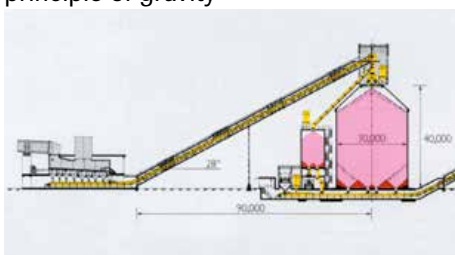

Plant planning – Clinker silo with proportional addition of low-burnt clinker and truck loading

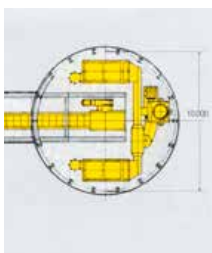

Filter and blower arrangement

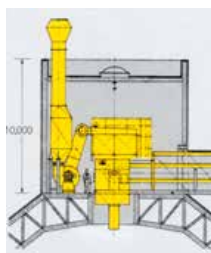

Headhouse with conveyor drive station and filter

Clinker Discharge

Minimising dust generation without the use of dust filters

To reclaim the clinker, discharge systems which can be operated without the use of dust filters, are the preferred equipment for all kinds of clinker storage facilities.

The gravity discharge gate, combined with a pan conveyor reclaiming the clinker at low speed minimises dust generation. The conveying capacity is defined by

the adjustable discharge cross section and the pan conveyor speed. Frequency controlled drive units allow adapting the conveying capacity to operational requirements.

Deep-Drawn Pan Conveyors are the ideal equipment to combine with the gravity discharge system. With an optimum plant planning the Deep-Drawn Pan Conveyor allows for direct feeding of the mill hoppers in the grinding section.

Dust Suppression

In order to avoid dust emissions from the clinker storage hall, negative pressure needs to be created in the feeding area. For this purpose, the filter system must be designed for an operating temperature of 100 °C. The air volume required depends on the storage diameter and the clinker temperature, which essentially influences the buoyant forces.

About 12,000 m³/h are required for small cylindrical silos and up to 60,000 m³/h or more for large-sized circular storage halls.

Vent hopper and compact filter systems proved to be a space sparing solution. A favourable load distribution is achieved if two filters are served by one blower.



Installation of new bucket strand

Conversions and Refurbishments

- Upgrading of existing plant components
- Targeting increased efficiency
- Higher output
- Improved availability

With our expert team of engineers planning selective modernisation measures, we pay special attention to the upgrading of existing plant components, targeting increased efficiency, higher output rates and improved availability.

Upgrading of your materials handling and storage equipment to state-of-the-art technology is achieved through a tailor-made refurbishment process under optimum utilisation of time and budget.

Most of the existing components are re-used in the refurbishment process to save cost.

Engineered conversions and refurbishments for increased efficiency and output are performed on AUMUND equipment as well as on the equipment of other manufacturers.



Pre-assembly of chain strands

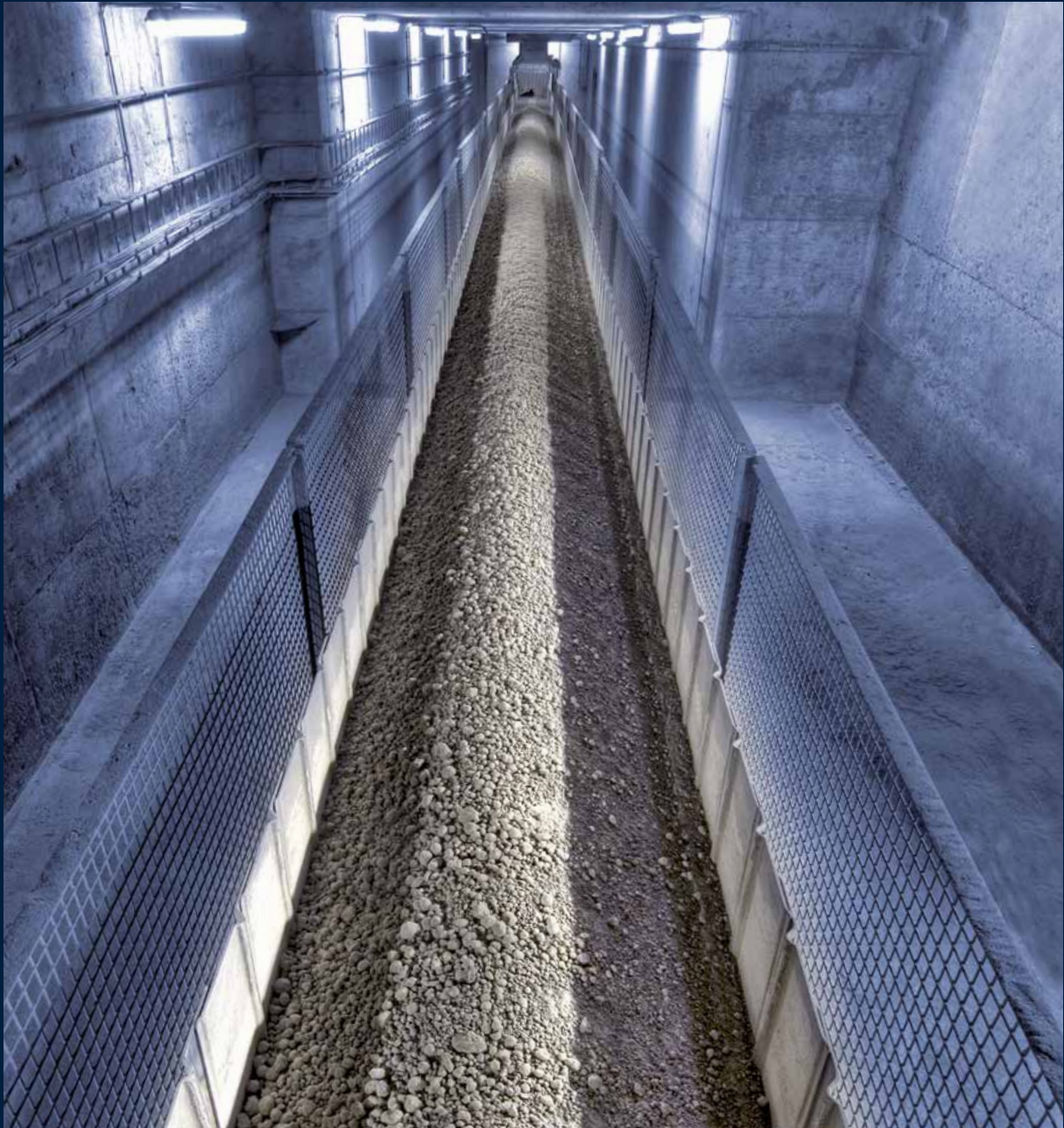

Pan Conveyors

CONTENT

2 AUMUND Pan Conveyors

4 Pan Conveyor with Deep Drawn Pans type KZB

8 Pan Conveyor with Deep Drawn Pans and Baffles type KZB-Q

10 Pan Conveyor with Buckets type BZB

14 Pivoting Pan Conveyor type SPB

18 Reversible Deep-Drawn Pan Conveyor type KZB-R

19 Silo Discharge type SAK

20 Components Chain Technology

21 Accessories

22 Conversions and Refurbishments

23 After Sales Services

AUMUND Pan Conveyors

Technology with proven quality, strength and reliability

AUMUND Pan Conveyors are designed to suit efficiency driven process technologies and to ensure system performance.

At AUMUND we know that trouble-free operation of the conveying equipment is vital for the productivity and profitability of the whole plant. Keeping in mind this objective we are committed to our high quality standards which are reflected in the exceptional service life of the AUMUND Pan Conveyor.

Our focus is to satisfy specific requirements with creative, cost-effective solutions for the transport of the whole range of bulk materials in cement production from limestone, cement and additives to hot and abrasive cement clinker.

With more than 90 years in industrial engineering of conveying equipment we also assist customers worldwide with conceptual layouts and configuration. Our primary goal is to identify and provide the most efficient and economic conveying routes.

- For the whole range of bulk materials in cement production
- Engineered to suit plant and operator needs
- High quality standards
- Outstanding service life
- Efficient and economic conveying routes



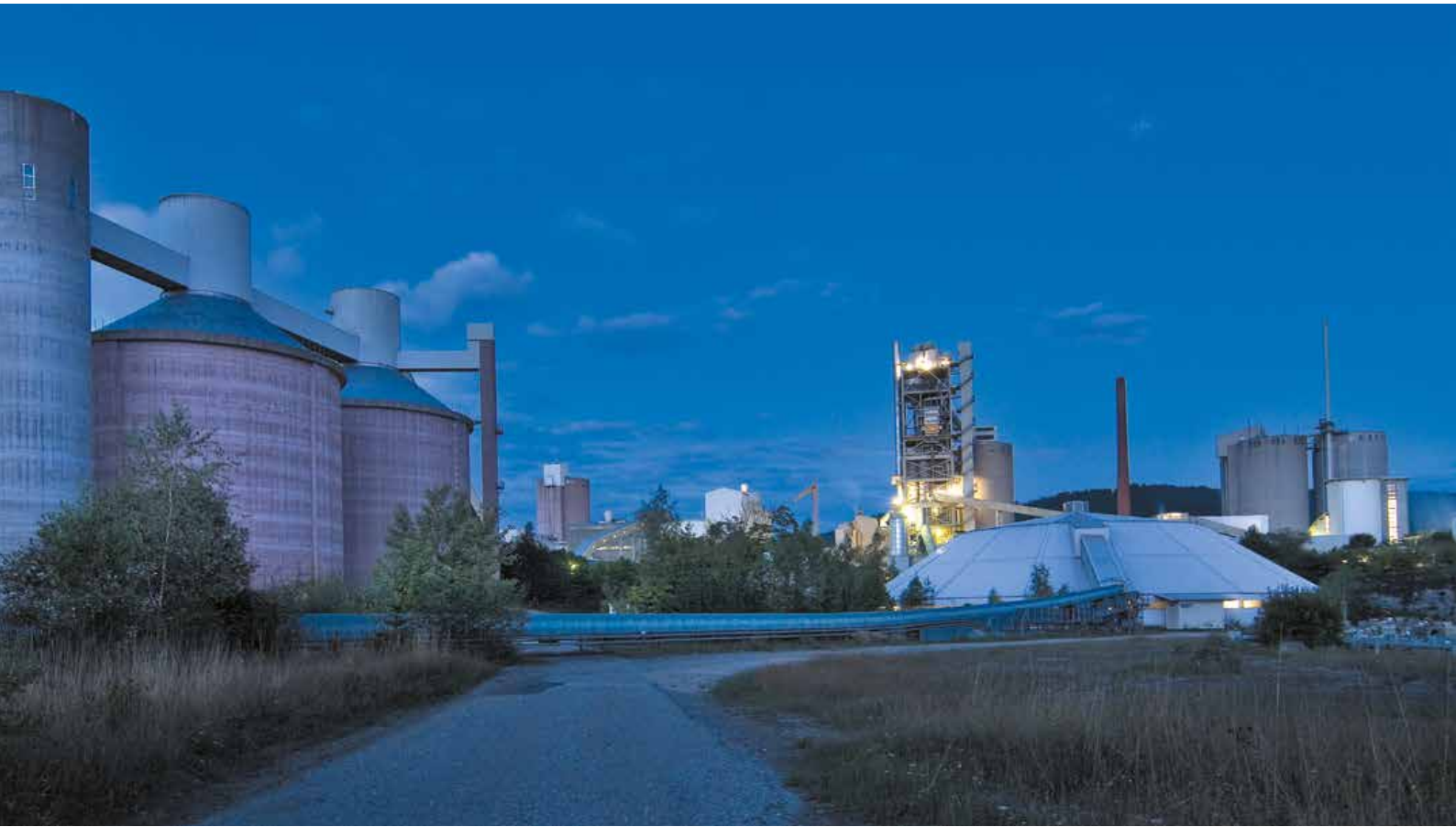

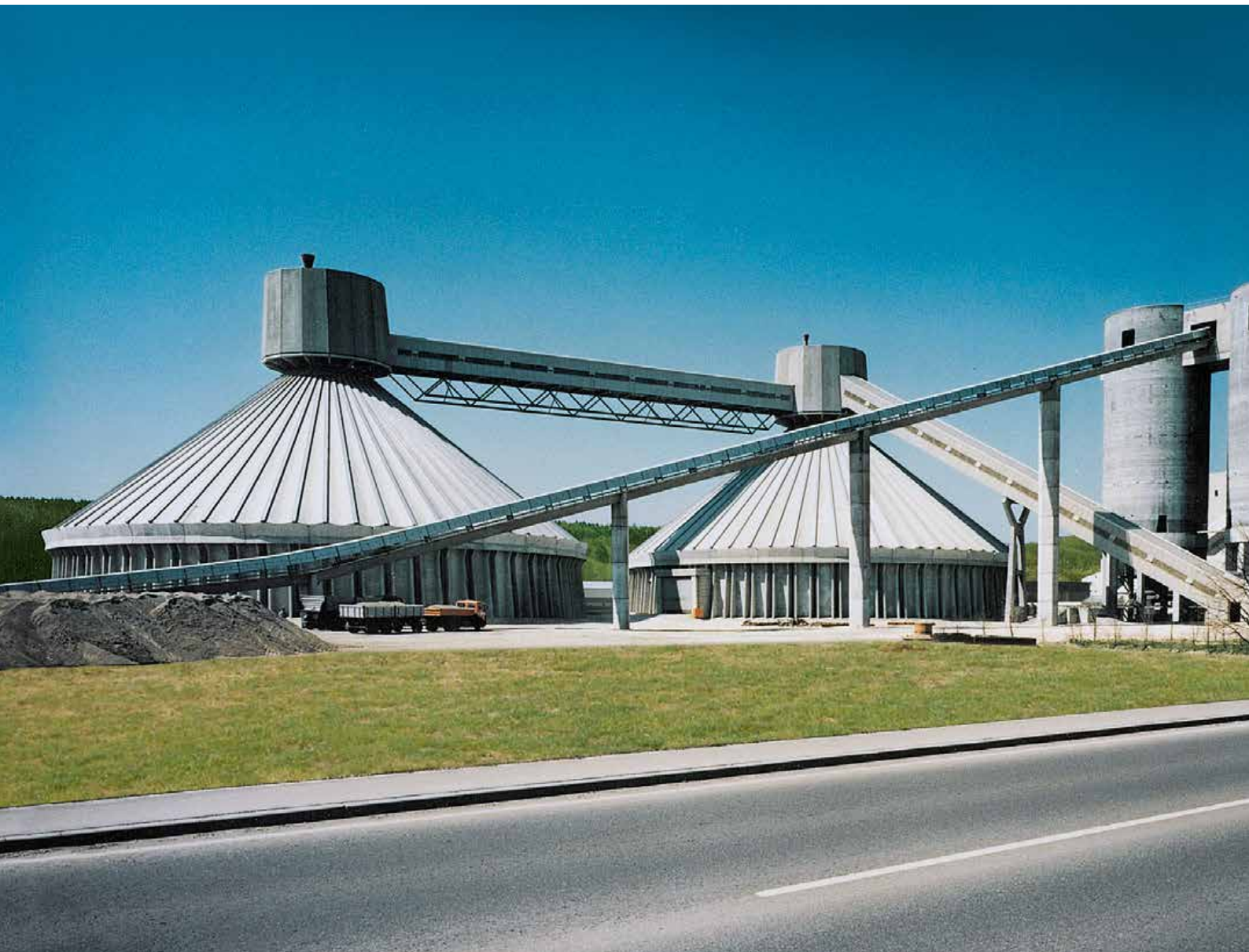

Conveying route with Pan Conveyor KZB

Pan Conveyor with Deep Drawn Pans type KZB

The Pan Conveyor with deep drawn pans type KZB is designed to suit slopes matching the angle of repose of the conveyed bulk material.

For clinker handling the Pan Conveyor type KZB suits conveying routes with an inclination up to 30°.

This Pan Conveyor type is the ideal direct connection between cooler and clinker stock especially for applications with grate coolers. The design allows the Pan Conveyor to be arranged underneath the whole cooler length and to collect the fines from the dust collecting hoppers same as the clinker from the crusher.

Installed underneath the clinker stock in combination with the AUMUND Silo Discharge Gate, the Pan Conveyor with deep drawn pans type KZB allows for dust-controlled clinker reclaim.

- Designed for conveying routes with up to 30° inclination
- Conveying heights exceeding 75 m
- Conveying capacities exceeding 1,000 t/h
- Chains with 290 to 3,000 kN breaking load per strand

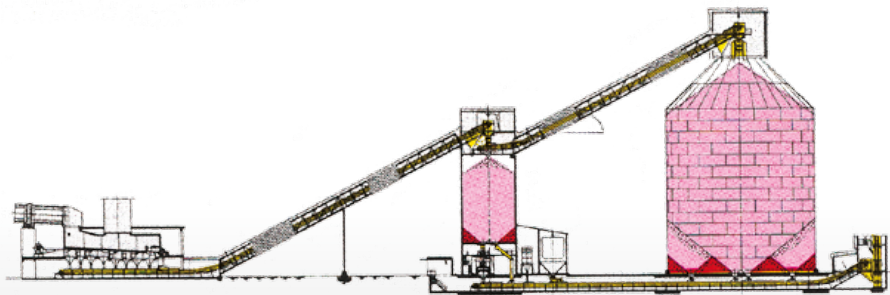
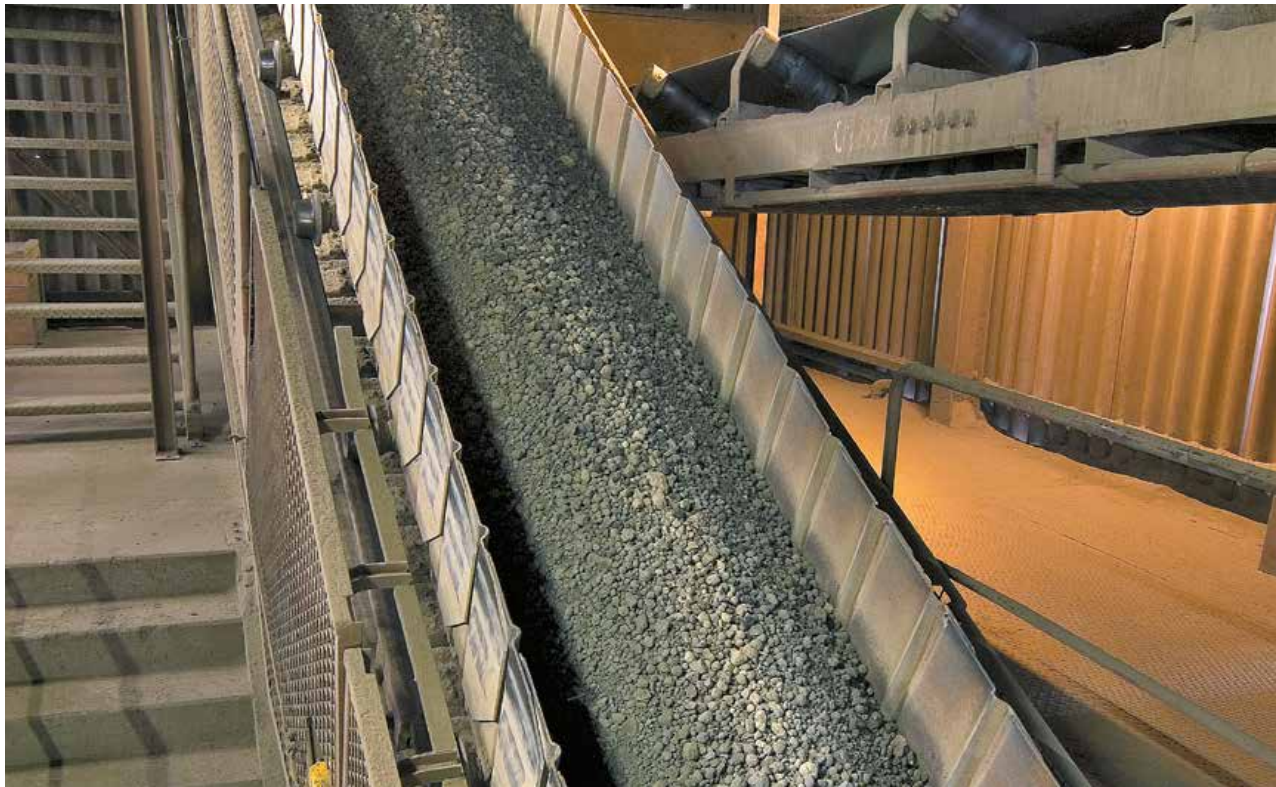

Deep Drawn Pan Conveyor under Clinker Cooler



Features

- Accepts temperatures to 700 °C
- Designed as a modular structure with standard components
- Profiled pans for high rigidity
- Minimum spillage
- Highly wear resistant chains with high yield strength
- High quality standards on all components

Benefits

- Efficient and reliable operation
- Reduced installation time
- Low operating costs
- Minimum and easy maintenance
- Low power consumption
- Low overall investment cost
- Outstanding service life



Pan Conveyor with Deep Drawn Pans type KZB

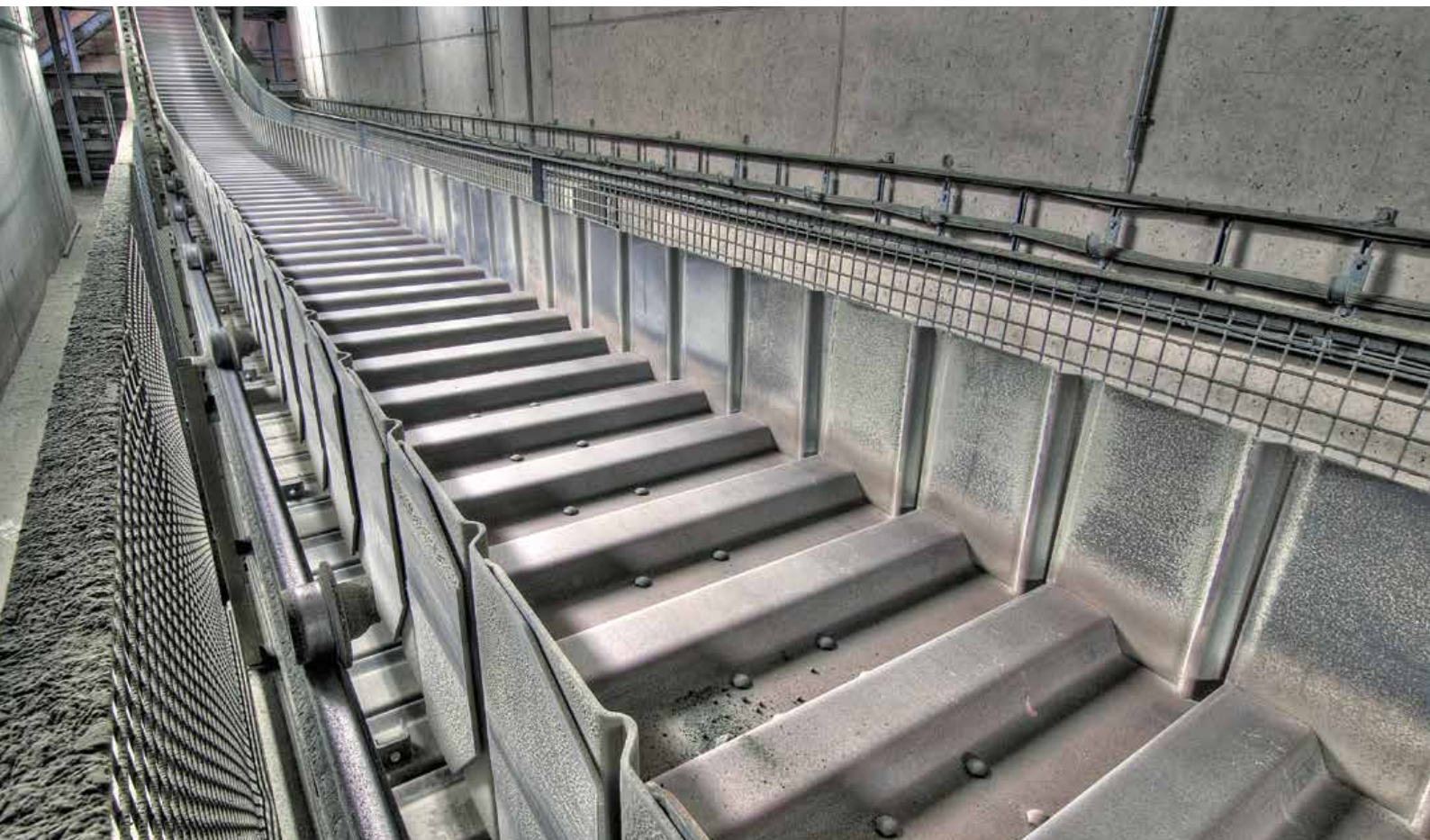

Pan Conveyor type KZB - Detail



Deep-Drawn Pan Conveyor - Detail

Conveying Capacities - Pan Conveyor type KZB

The capacities indicated correspond to a brimfull filling (water filling) = 100%.
Capacity reduction factor subject to angle of inclination.

Conveyor section type KZB		Theoretical conveying capacity m ³ /h					
Width mm	Side wall height mm	Conveying speed m/s					
		0.10	0.15	0.20	0.25	0.30	0.35
400	100	12	17	23	29	35	40
400	150	19	28	37	47	56	66
400	200	26	39	52	65	78	91
400	250	33	50	66	83	99	116
400	300	40	60	81	101	121	141
600	150	28	42	56	70	84	98
600	200	39	58	78	97	117	136
600	250	50	75	99	124	149	174
600	300	60	91	121	151	181	212
600	350	71	107	143	178	214	249
800	200	52	78	104	130	156	181
800	250	66	99	132	166	199	232
800	300	81	121	161	202	242	282
800	350	95	143	190	238	285	333
800	400	109	164	219	274	328	383
1,000	200	65	97	130	162	194	227
1,000	250	83	124	166	207	248	290
1,000	300	101	151	202	252	302	353
1,000	350	119	178	238	297	356	416
1,000	400	137	205	274	342	410	479
1,200	200	78	117	156	194	233	272
1,200	250	99	149	199	248	298	348
1,200	300	121	181	242	302	363	423
1,200	350	143	214	285	356	428	499
1,200	400	164	246	328	410	492	575
1,400	250	116	174	232	290	348	406
1,400	300	141	212	282	353	423	494
1,400	350	166	249	333	416	499	582
1,400	400	192	287	383	479	575	670
1,400	450	217	325	433	542	650	759
1,600	250	132	199	265	331	397	464
1,600	300	161	242	323	403	484	564
1,600	350	190	285	380	475	570	665
1,600	400	219	328	438	547	657	766
1,600	450	248	372	495	619	743	867
1,800	250	149	224	298	373	447	522
1,800	300	181	272	363	454	544	635
1,800	350	214	321	428	535	642	748
1,800	400	246	369	492	616	739	862
1,800	450	279	418	557	697	836	975
2,000	250	166	248	331	414	497	580
2,000	300	202	302	403	504	605	706
2,000	350	238	356	475	594	713	832
2,000	400	274	410	547	684	821	958
2,000	450	310	464	619	774	929	1,084
2,200	250	182	273	364	455	546	638
2,200	300	222	333	444	554	665	776
2,200	350	261	392	523	653	784	915
2,200	400	301	451	602	752	903	1,053
2,200	450	341	511	681	851	1,022	1,192
2,400	250	199	298	397	497	596	696
2,400	300	242	363	484	605	726	847
2,400	350	285	428	570	713	855	998
2,400	400	328	492	657	821	985	1,149
2,400	450	372	557	743	929	1,115	1,300

The characteristic profile of the pans with their contact-free overlapping offers high rigidity with large pan widths and a closed surface in the return stations. Stiffeners pressed into the side plates combined with a sealing edge of special design provide the tight fitting to avoid spillage.

The range of AUMUND conveyor chains covers a large range of applications, from small capacities and horizontal conveying routes to high capacities and lifts.

The chain - for single or double strand application - is chosen to suit the actual traction force while the roller size is chosen in accordance with the weight of the pan conveyor itself and the conveyed material.

The drive units feature bevel spur gears either foot mounted with flexible coupling or shaft-mounted. For inclined conveying, the gear box is fitted with a back stop or, alternatively, a flexible coupling with brake is arranged between gear box and motor.

The coupling between motor and gear box can be hydraulic or flexible for soft start-up. Frequency converters adapt the conveying speed to the actual conveying capacity.



Pan Conveyor KZB-Q connecting cooler and silo

Pan Conveyor with Deep Drawn Pans and Baffles type KZB-Q

- Designed for conveying routes with up to 45° inclination
- Conveying heights to 78 m
- Conveying capacities to 700 t/h
- Chains with 290 to 3,000 kN breaking load per strand



KZB-Q inclined at 45 degrees

For slopes exceeding 30 degrees retainer baffles are fitted to the deep drawn pans. These baffles are welded to the bottom plate and held in a loose fitting by cams which are pressed into the upper part of the side boards. The loose fitting allows the baffles to bend in case foreign bodies get onto the conveyor.

All further parts of the KZB-Q are interchangeable with the KZB. These standardized components constitute the AUMUND modular system for easy field assembly and interchangeability, an important asset for spare parts administration.



Deep Drawn Pans with Baffles

Conveying Capacities - Pan Conveyor type KZB-Q

The capacities indicated correspond to a brimfull filling (water filling) = 100%. Capacity reduction factor subject to angle of inclination.

Conveyor section type KZB-Q		Theoretical conveying capacity m ³ /h					
Width mm	Side wall height mm	Conveyor speed m/s					
		0.10	0.15	0.20	0.25	0.30	0.35
400	250	33	50	66	83	99	116
400	300	40	60	81	101	121	141
400	350	48	71	95	119	143	166
400	400	55	82	109	137	164	192
600	250	50	75	99	124	149	174
600	300	60	91	121	151	181	212
600	350	71	107	143	178	214	249
600	400	82	123	164	205	246	287
800	250	66	99	132	166	199	232
800	300	81	121	161	202	242	282
800	350	95	143	190	238	285	333
800	400	109	164	219	274	328	383
800	450	124	186	248	310	372	433
1,000	250	83	124	166	207	248	290
1,000	300	101	151	202	252	302	353
1,000	350	119	178	238	297	356	416
1,000	400	137	205	274	342	410	479
1,000	450	155	232	310	387	464	542
1,200	250	99	149	199	248	298	348
1,200	300	121	181	242	302	363	423
1,200	350	143	214	285	356	428	499
1,200	400	164	246	328	410	492	575
1,200	450	186	279	372	464	557	650
1,400	250	116	174	232	290	348	406
1,400	300	141	212	282	353	423	494
1,400	350	166	249	333	416	499	582
1,400	400	192	287	383	479	575	670
1,400	450	217	325	433	542	650	759
1,600	300	161	242	323	403	484	564
1,600	350	190	285	380	475	570	665
1,600	400	219	328	438	547	657	766
1,600	450	248	372	495	619	743	867
1,800	300	181	272	363	454	544	635
1,800	350	214	321	428	535	642	748
1,800	400	246	369	492	616	739	862
1,800	450	279	418	557	697	836	975
2,000	300	202	302	403	504	605	706
2,000	350	238	356	475	594	713	832
2,000	400	274	410	547	684	821	958
2,000	450	310	464	619	774	929	1,084
2,200	300	222	333	444	554	665	776
2,200	350	261	392	523	653	784	915
2,200	400	301	451	602	752	903	1,053
2,200	450	341	511	681	851	1,022	1,192
2,400	300	242	363	484	605	726	847
2,400	350	285	428	570	713	855	998
2,400	400	328	492	657	821	985	1,149
2,400	450	372	557	743	929	1,115	1,300



Feeding of covered stockpile

Pan Conveyor with Buckets type BZB

- Designed for conveying routes with up to 60° inclination
- Conveying heights to 96 m
- Conveying capacities to 500 t/h
- Chains with 290 to 3,000 kN breaking load per strand

Wherever conveying of clinker with a high content of fines is required, the Bucket Conveyor type BZB is the most appropriate choice. The bucket design with either forward or backward overlapping is designed to suit this particular application and minimizes spillage and cleaning.

Designed for conveying at an inclination up to 60 degrees, the Bucket Conveyor fits into layouts combining high elevation with restricted space. The narrow curve radius is a further feature to suit these applications where only limited space is available, a considerable advantage for modernization projects or conversion in existing plants.

Uniform bucket filling and even material distribution over the whole bucket width is ensured by expert planning of the feed chute system - a pre-requisite for trouble-free operation with minimum dust generation.



Bucket Apron Conveyor



Feeding of mill hoppers



Clinker Transport with Conveyor type BZB



Bucket Apron Conveyor type BZB Detail

Conveying Capacities - Bucket Conveyor type BZB

The capacities indicated correspond to a brimfull filling (water filling) = 100%. Capacity reduction factor subject to angle of inclination.

Width mm	Side wall height mm	Theoretical conveying capacity m ³ /h					
		Conveyor speed m/s					
		0.10	0.15	0.20	0.25	0.30	0.35
400	200	21	31	42	52	62	73
400	250	27	40	54	67	81	94
600	200	31	47	62	78	94	109
600	250	40	60	81	101	121	141
600	300	49	74	99	123	148	172
800	250	54	81	107	134	161	188
800	300	66	99	131	164	197	230
800	350	78	117	155	194	233	272
800	400	90	135	179	224	269	314
1,000	300	78	117	156	196	235	274
1,000	350	92	138	184	230	277	323
1,000	400	106	159	212	265	318	372
1,200	350	111	166	221	277	332	387
1,200	400	127	191	255	318	382	446
1,400	350	129	194	258	323	387	452
1,400	400	149	223	297	372	446	520
1,600	350	148	221	295	369	443	516
1,600	400	170	255	340	425	510	594

The bucket - standard widths to 1,600 mm - feature a built-in stiffener for high solidity.

Depending on the case of application the overlapping of the buckets is either forward or backward. With the tight bucket arrangement the BZB meets the criteria for proper feeding with minimum spillage.

The modular system also applies for the AUMUND Bucket Conveyor, ensuring interchangeability and combination with components like those used with the Deep Drawn Pan Conveyor.

Features

- Ideal for conveying of clinker with a high content of fines
- Narrow curve radius, down to 10 m
- Expert design of the feed chute system
- Designed as a modular structure with standard components
- Minimum spillage
- Highly wear resistant chains with high yield strength
- High quality standards on all components

Benefits

- Efficient and reliable operation
- Suits applications with limited space
- Low operating costs
- Minimum and easy maintenance
- Outstanding service life



Feeding two silos in line

Pivoting Pan Conveyor type SPB

For bulk material distribution into a series of silos or hoppers, the Pivoting Pan Conveyor offers the most versatile arrangements.

The Pivoting Pan Conveyor ensures PLC controlled multiple distribution of various materials with just one conveyor.

- Pan reversing system for simultaneous conveying on the upper and lower run
- Intermediate discharge stations placed at any given position
- Upper and lower run feeding
- Specific feeding and discharge features

Feeding onto the upper run is performed with a standard feed chute whilst a two-way chute leads the bulk material to the lower run. Equipped with an overflow system the feed chutes also ensure direct discharge of the bulk material into the silo or hopper.

Intermediate discharge stations may be positioned where required and permit remote controlled switching from one discharge station to the other.

Bulk material directed onto the upper run can subsequently be transferred to the lower run through an intermediate discharge station located on the upper run.

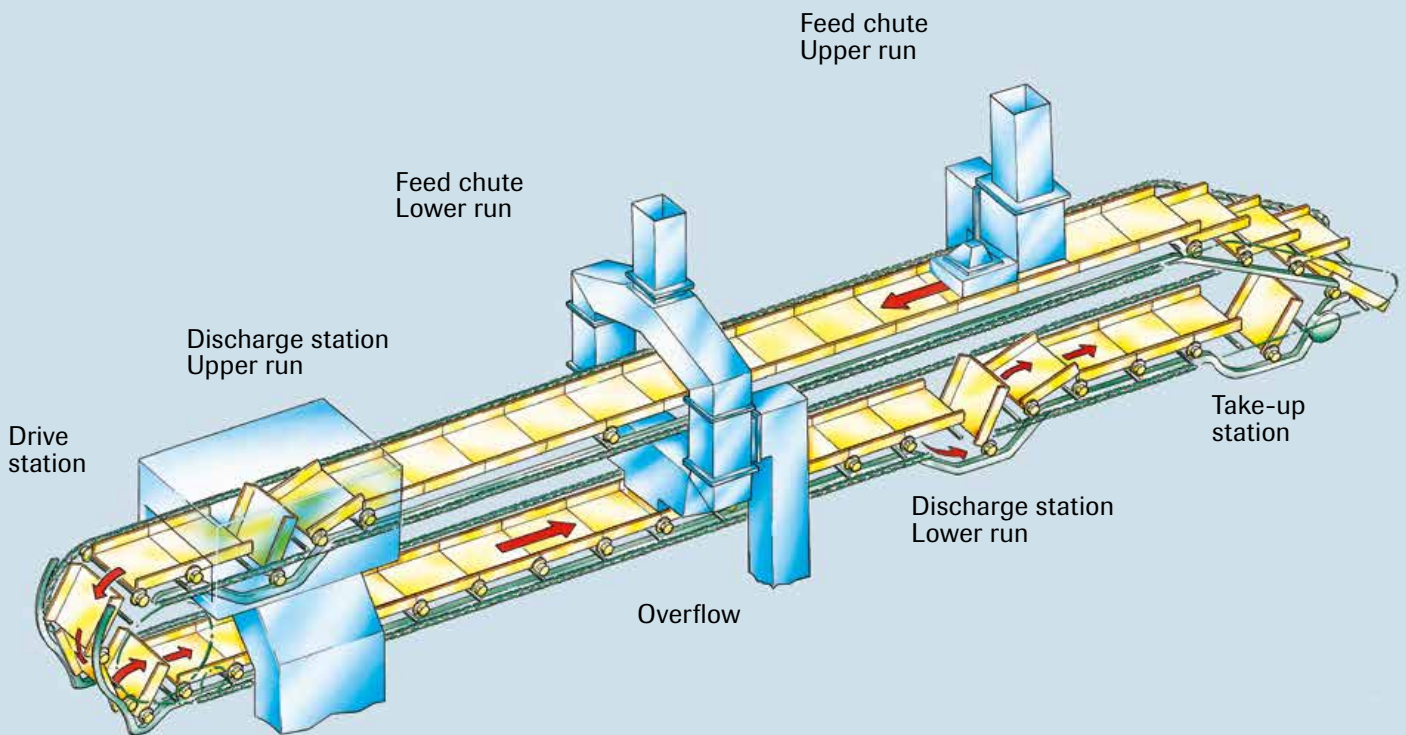

Upper and lower run feeding and discharge

The material may then be distributed into clinker silos or mill hoppers through discharge stations on the lower run. Simultaneous conveying on the upper and the lower run is a further alternative. A hopper can thus be loaded with cement clinker by way of the lower run whilst for example gypsum is conveyed on the upper run.



Mill hopper feeding

Bulk Material Distribution into Storage Halls

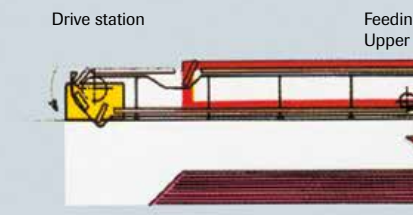
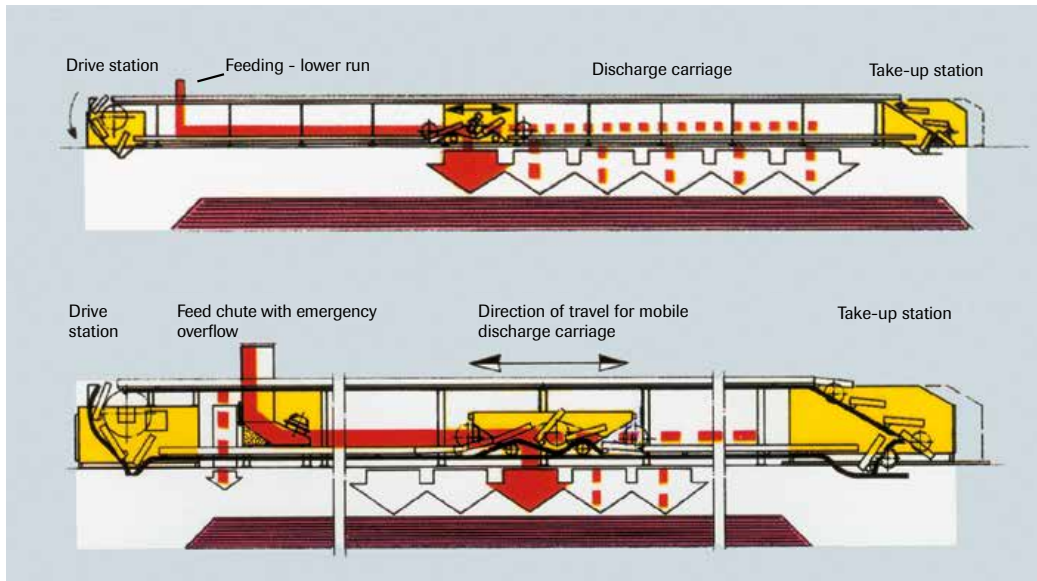

Bulk Material Distribution into a Series of Silos

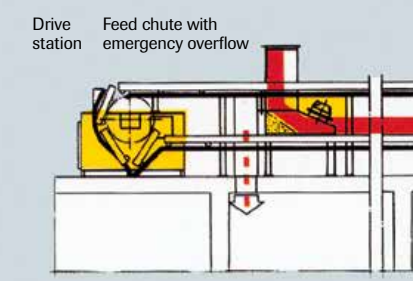
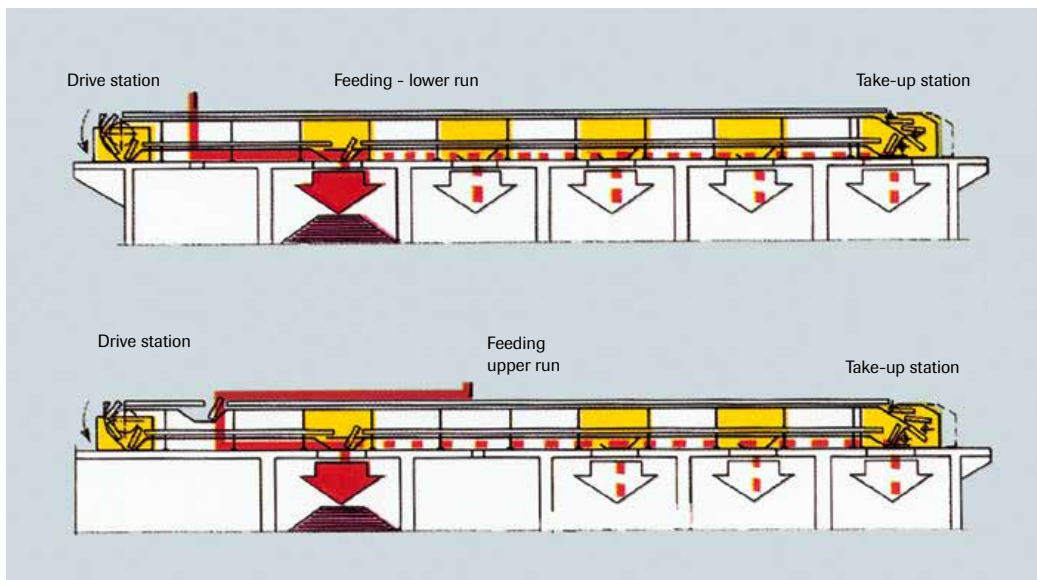

Bulk Material Distribution into Silos and Storage Hall

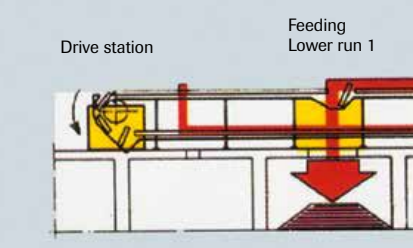
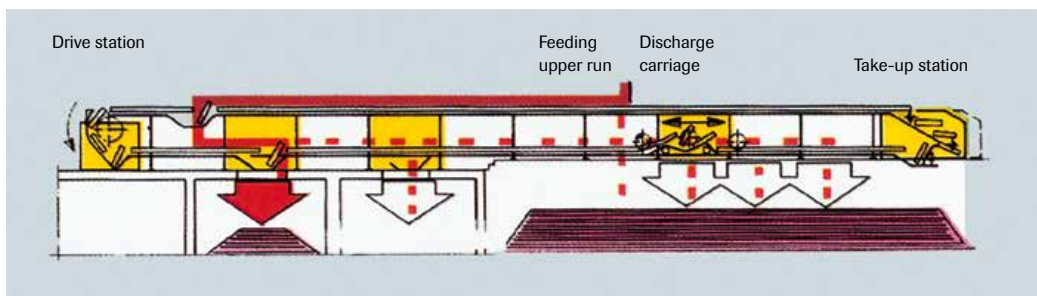

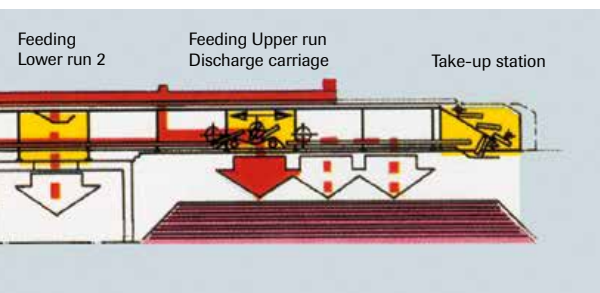
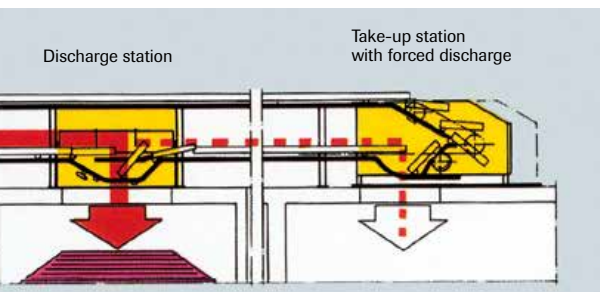
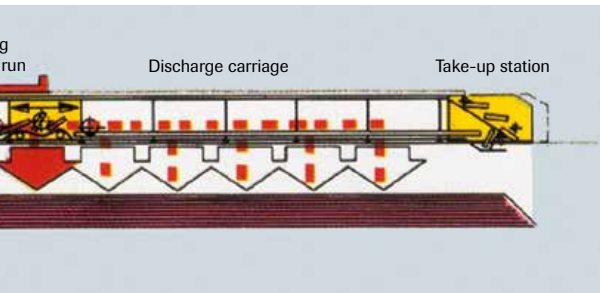

Conveying capacity - Pivoting Pan Conveyor type SPB

The capacities indicated correspond to a brimfull filling (water filling) =100%

Conveyor section		Theoretical conveying capacity m ³ /h					
Pan width Plw mm	Side wall height mm	Conveyor speed m /s					Filling rate limit
		0.10	0.15	0.20	0.25	0.30	
400	150	22	32	43	54	65	115%
400	200	29	43	58	72	86	105%
600	150	32	49	65	81	97	120%
600	200	43	65	86	108	130	110%
800	150	43	65	86	108	130	125%
800	200	58	86	115	144	173	115%
1,000	150	54	81	108	135	162	130%
1,000	200	72	108	144	180	216	120%
1,200	150	65	97	130	162	194	135%
1,200	200	86	130	173	216	259	125%
1,400	150	76	113	151	189	227	140%
1,400	200	101	151	202	252	302	130%
1,600	150	86	130	173	216	259	140%
1,600	200	115	173	230	288	346	130%

Theoretical rate limit

Filling rate limit

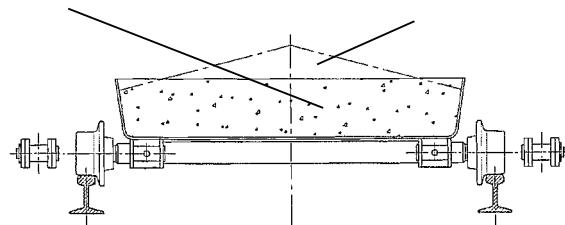

Feeding of long clinker storage halls requires continuous shifting of the discharge point. A mobile discharge carriage which can be moved to any given position above the hall is used with this particular application. The clinker is continuously distributed over the whole travel length of the carriage.

- Automated feeding of clinker silos, mill hoppers and clinker halls
- Simultaneous conveying of different bulk materials
- PLC-controlled operation
- Automated material distribution controlled by level sensors
- Customized layout and planning
- Standardized components

Sensors on the conveyor supports monitor the position of the travelling carriage. Level indicators control automatic shifting of the carriage as soon as a maximum filling level is reached inside the storage hall.



Clinker Silos 2 x 60,000 t

Reversible Deep-Drawn Pan Conveyor type KZB-R

For applications where conveying in both directions is required, the Deep Drawn Pan Conveyor may be converted into a reversible conveyor. Alternate feeding of two silos with just one conveyor is made possible by simply changing the conveying direction.

This conveyor of special design suits horizontal arrangements. The illustration shows a plant where feeding of two clinker silos is performed with one Bucket Elevator and one Reversible Conveyor. The Bucket Elevator unloads the clinker in the centre of the subsequent Reversible Conveyor which then feeds the clinker to either one of the silos.

Operation of the Reversible Conveyor is PLC controlled from the central control room ensuring that the pans

are cleared before shifting from one direction to reverse conveying.

To achieve this type of operation the pans are arranged such that the pan overlapping always points into the chosen conveying direction.

If required with a long centre distance, both conveyor ends are fitted with a drive unit.

- Alternate feeding of two silos with one conveyor
- Conveying in both directions by simply shifting to reverse conveying

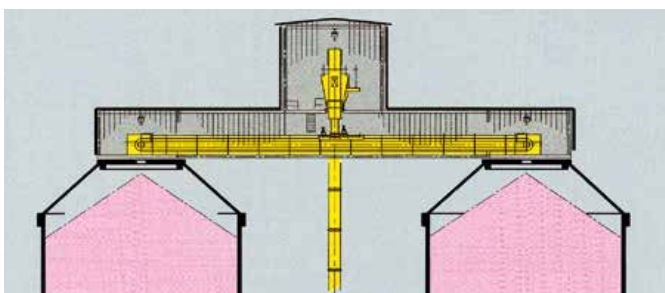

Clinker silo feeding with reversible pan conveyor

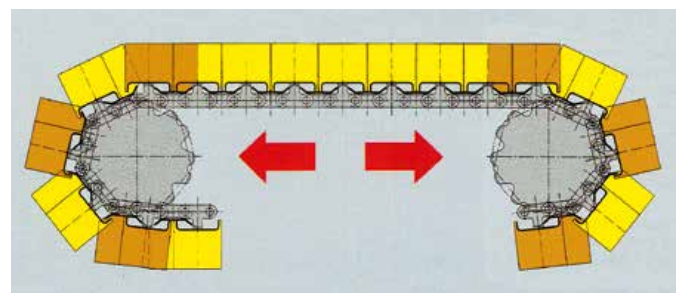

Reversible pan conveyor - functional principle



Silo Discharge with Remote Control

Silo Discharge type SAK

For clinker silo discharge with low dust emission, for proportional addition of low-burnt or imported clinker AUMUND's product range includes the Gravity Discharge Unit operating in combination with the Deep Drawn Pan Conveyor. The height of the material layer on the pan conveyor determines the discharge rate and the feeding capacity onto the subsequent conveying equipment. Preset during commissioning, it is adjusted to the specific requirements of the plant.

With its built-in motorized shell gate the Gravity Discharge Unit prevents the clinker from falling in an uncontrolled manner onto the pan conveyor. It reclaims the clinker at low speed and minimizes dust generation.

Where adequate, the Gravity Discharge Unit may also be manually operated.

For uniform discharge of the stored volume, a multitude of motorized Gravity Discharge Units are installed underneath the clinker silo. Switching between discharge points is made by remote control assisted by ultrasonic sensors detecting lack of clinker on the conveyor.



Components

AUMUND Pan Conveyors feature standardized components forming part of the modular system. Components of different pan conveyor types are interchangeable, a major advantage for spare parts management.

- Bogie-type rails ranging from size S14 to S30, chosen to suit the pan conveyor size
- Roller guide-rails in the curve area
- Standard roller design with tempered running surface and multiple sealing and life lubrication
- Drive and tail shaft sprockets with exchangeable toothed segments for easy replacement
- Sprockets with double tooth pitch meshing with the sprocket teeth only after each second turn for increase of lifetime
- Chains with breaking loads ranging from 290 kN to 3,000 kN

Type	for conveyor type	breaking load kN
AU3032.1	KZB	
BAU3032.1	BZB	290
AU4540.1	KZB	
BAU4540.1	BZB	510
AU5544.1	KZB	
BAU5544.1	BZB	700
AU6052.1	KZB	
BAU6052.1	BZB	900
AU6060.1	KZB	
BAU6060.1	BZB	1,200
AU8076.1	KZB	
BAU8076.1	BZB	1,900
AU9085.1	KZB	
BAU9085.1	BZB	2,350
AU10090.1	KZB	
BAU10090.1	BZB	3,000

Chain pitch 250 mm

Chain Technology

- High precision manufacturing technology
- Special, wear-resistant steel
- High yield strength

AUMUND chains for Pan Conveyors are fabricated from special steel suitable for accurate laser cutting. The high precision manufacturing technology combines high yield strength with perfect distribution of forces.

The chain features a divided chain locking link, so field assembly is simplified.



Accessories

- Two way distribution chute
- Three way distribution chute
- Motorized flat gate
- Maintenance trolley for conveyor bridge

Remote control of downstream conveying directions is performed with the AUMUND two or three-way distribution chute. The chutes are fitted with shell gates actuated either by a gear motor or a hydraulic / pneumatic cylinder. Casing and shell gates are of wear-resistant design for a long service life. Motorized flat gates of sturdy design complete the range of accessory equipment for material distribution.

In addition, AUMUND offers maintenance trolleys with rack and pinion drive to be installed inside conveyor bridges for transportation of heavy tools, oil bins or equipment components to the top of high clinker silos. The maintenance trolleys are designed to suit any angle of inclination.

The range of accessory equipment is completed by truck and ship loading systems with low dust generation and electronic control for easy loading operations.



Installation of new bucket strand

Conversions and Refurbishments

- Upgrading of existing plant components
- Targeting increased efficiency
- Higher output
- Improved availability

With our expert team of engineers planning selective modernisation measures, we pay special attention to the upgrading of existing plant components, targeting increased efficiency, higher output rates and improved availability.

Upgrading of your materials handling and storage equipment to state-of-the-art technology is achieved through a tailor-made refurbishment process under optimum utilisation of time and budget.

Most of the existing components are re-used in the refurbishment process to save cost.

Engineered conversions and refurbishments for increased efficiency and output are performed on AUMUND equipment as well as on the equipment of other manufacturers.



Pre-assembly of chain strands



Rotary Discharge Machine

CONTENT

2	Rotary Discharge Machines
----------	---------------------------

3	Rotary Discharge Machine type BEW-BL
----------	---

6	Rotary Discharge Machine type BEW-BL
----------	---

7	Data Sheet
----------	------------

9	Rotary Discharge Machine type BEW-FL
----------	---

10	Rotary Discharge Machine type BEW-FL with Weigh Feeder
-----------	---

11	Data Sheet
-----------	------------

12	Rotating Rotary Discharge Machine type BEW-K
-----------	---

15	Bulk Material testing in our laboratory
-----------	--

16	Components
-----------	------------

18	Conversions and Refurbishments
-----------	--------------------------------

19	After Sales Service
-----------	---------------------

Rotary Discharge Machines

For a variety of applications wherever difficult bulk material needs to be discharged from

- Rectangular hoppers
- Open stockpiles
- Large cylindrical silos

All LOUISE Rotary Discharge Machines feature the logarithmically shaped discharge arms and automatic operation including reverse travel.

Three basic alternatives:

- Block Model type BEW-BL
- Low Profile Model type BEW-FL
- Rotating Model type BEW-K

Materials which can be handled:

- FGD-gypsum
- Coal
- Gypsum
- Limestone
- Lignite
- Clay
- Marl
- Petcoke



Rotary Discharge Machine type BEW-BL

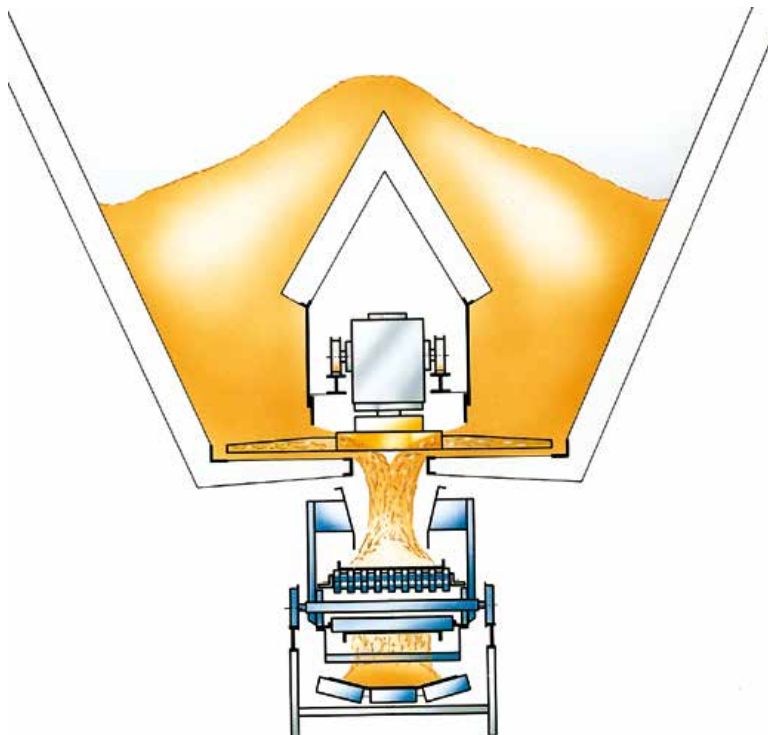

Double side discharge for rectangular hoppers

The block-type Rotary Discharge Machine is designed for double side discharge.

All drive components are located in a solid casing.

The machine moves inside a tunnel and reclaims the product from both sides.

The hydraulic unit or the frequency controller allows to adjust the reclaim capacity.

Rotary Discharge Machine type BEW-BL

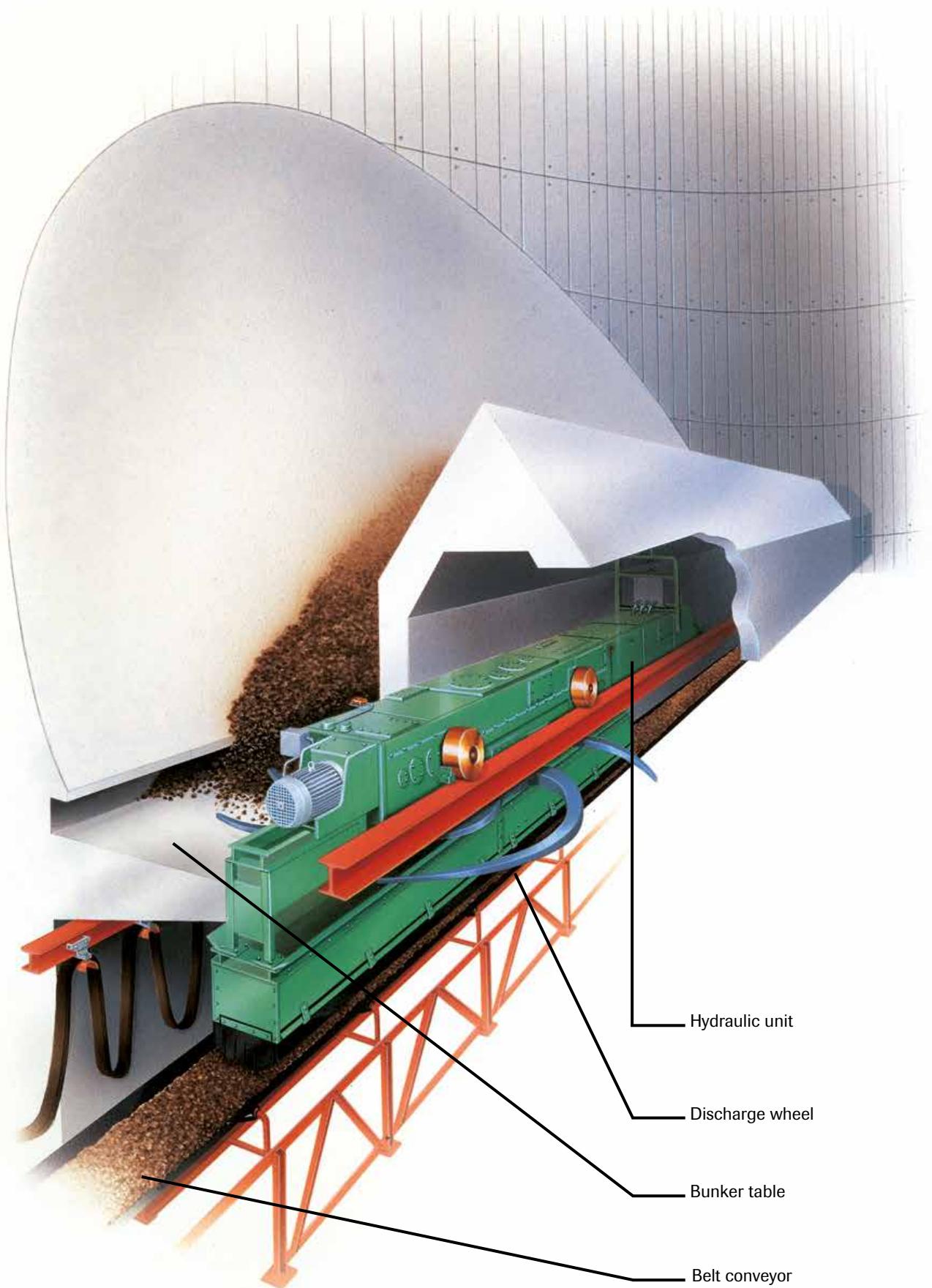



Denpatsu coal-fired power plant



Shikoku plant

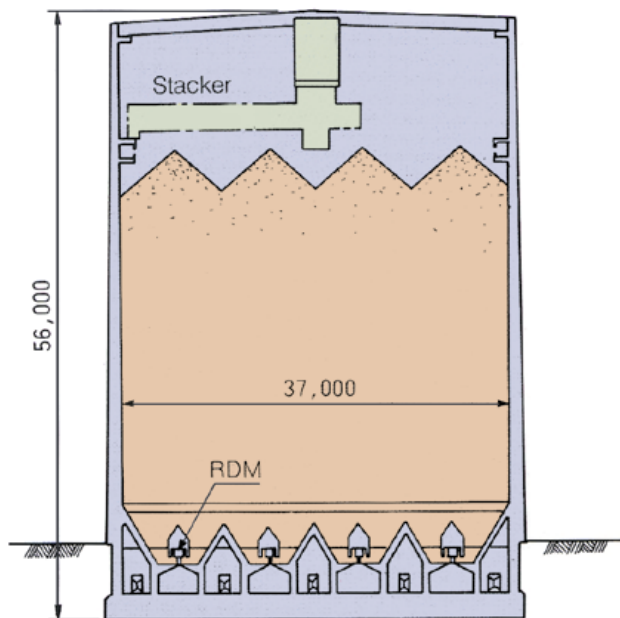

Cross section of Okinawa coal silo

Storage capacity of the 4 silos	50,000 m ³
Diameter of each silo	37 m
Height of each silo	56 m
Discharge capacity of each discharge machine	adjustable from 40 t/h to 400 t/h
Installed power	37 kW
Travel speed	0.92 to 3.72 m/min
Diameter of discharge wheel	4,000 mm

Coal storage and reclaim

The Ishikawa power plant, Okinawa - Japan, features four silos with a storage volume of 50,000 m³. These silos, ranging among the largest worldwide, were built by Mitsui Construction Co. Ltd.

The coal is discharged by four Rotary Discharge Machines arranged parallel to each other. Each discharge machine travels on rails installed in a concrete tunnel covering the whole length of the silos. This arrangement allows each individual machine to discharge from either one of the four silos. The travel distance exceeds 200 m.

The block-type discharge machine is designed in such a way that the coal is reclaimed from both- sides of the shelf. Each machine has a reclaim capacity of 40 t/h – 400 t/h and both the discharge wheel and the travel mechanism are hydraulically driven and adjustable. The discharge wheel's diameter of 4 m allows to cut deeply into the material column, an important feature to prevent bridging of the stored product. A material guide installed on the BEW serves as dust cover and guides the product onto the belt conveyor located underneath the Rotary Discharge Machine.

At the Shikoku coal-fired power plant of Electric Power Development Co. Ltd., the coal storage silos feature 8 Rotary Discharge Machines each reclaiming 1,000 t/h coal from two rows of 4 silos each. At the Denpatsu plant, 8 Rotary Discharge Machines reclaim from 2 rows of 2 silos each.



Rotary Discharge Machine type BEW-BL

Coal Handling - American Superior Midwest Energy Terminal, Wisconsin - USA

The coal extracted in open-cast mining is stored on an open stockpile during the winter season when shipping service is interrupted due to low temperatures. 6.5 million tons of coal can be stored on this open stockpile until the end of the winter season.

A total of 9 Rotary Discharge Machines reclaim the coal from this stockpile. Three machines each work in one unit and achieve a total reclaim capacity of 10,000 t/h. With this capacity and a discharge wheel diameter of 4 m, they range among the best performing reclaimers worldwide.

The discharge machines travel on rails inside a tunnel with a cone-shaped roof, continuously discharging the coal onto a belt conveyor also installed in the tunnel. When travelling back and forth, the discharge arms dig deeply into the coal through slots arranged in the tunnel. Each rotary discharge machine is driven by a 2.2 kW motor and travels the distance of 360 m with a velocity of 0.9 m/min.

In order to achieve a high torque with only 1 to 10 rpm, the discharge wheels are actuated by hydraulic units with 110 kW electric motor. If the discharge machines encounter high resistance due to the frozen status of the coal, the pressure sensors actuate the reverse mode and restart the machine. The drive unit is installed inside a compact casing with easy access.

The machines are in operation since 1976 and demonstrate the high availability of the LOUISE Rotary Discharge Machines.

Storage capacity	open stockpile, 6.5 million tons
Stockpile length	360 m
Discharge capacity of each discharge machine	3,300 t/h
Installed power	150 kW
Rotating speed of discharge wheels	adjustable from 1 to 10 rpm
Diameter of discharge wheels	4,000 mm
Travel speed	0.9 m/min

Data sheet

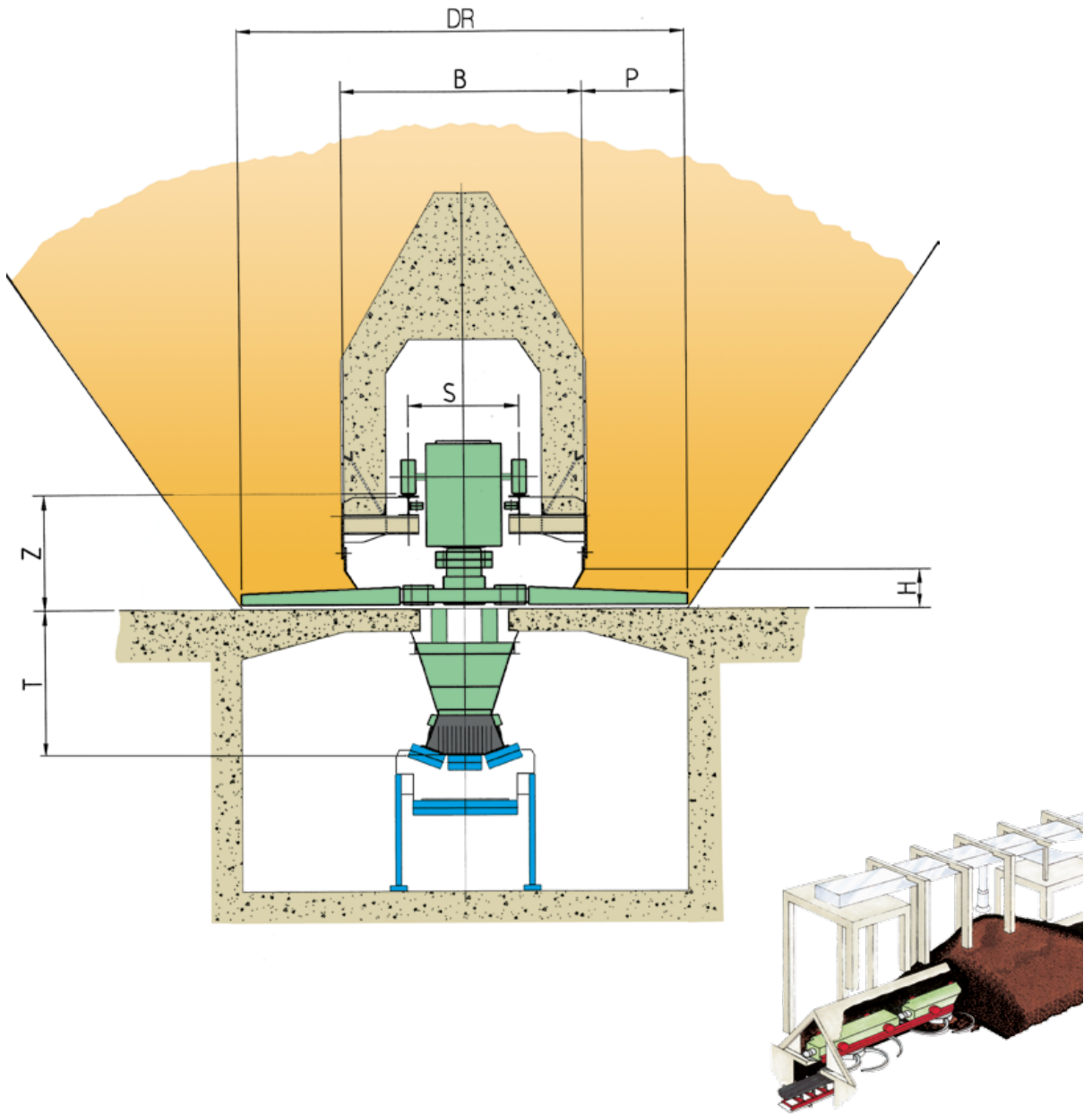

Rotary Discharge Machine type BEW-BL

discharge wheel diameter	discharge opening height	penetration depth	cone-shaped tunnel width	rail to hopper shelf height	hopper shelf to belt feeder height	theoretical capacity Q (m³/h) both-sided discharge with wheel speed n (rpm)				max. admissible travel speed
						range 1:10 circular speed at wheel tip				
						U = 0.3 m/s		U = 3.0 m/s		
(m³/h)	(rpm)	(m³/h)	(rpm)	(m/min)						
DR (mm)	H (mm)	P (mm)	B (mm)	Z (mm)	T (mm)					
2,000	200	350	1,300	600	1,000	94	(2.90)	940	(29.0)	6.35
2,500	250	450	1,600	775	1,100	138	(2.28)	1,380	(22.8)	6.35
3,000	300	700	1,600	775	1,100	225	(1.91)	2,250	(19.1)	6.35
4,000	400	1,000	2,000	1,030	1,200	410	(1.43)	4,100	(14.3)	6.35
5,000	500	1,150	2,700	1,030	1,200	580	(1.14)	5,800	(11.4)	6.35

Standard dimensions and capacity. Further dimensions and capacities on request.

BEW with single sided discharge

Discharge wheel with six arms, each with wear resistant front plate and armoured tip.



View onto discharge wheel

BEW with single sided discharge

- Festoon towing arm
- Safety limit switch
- Anti-collision sensor
- Travel distance sensor
- Travel distance limit switch
- Local control box
- Discharge wheel dust cover



BEW with single sided discharge



BEW with single sided discharge and double swivel mechanism



Rotary Discharge Machine type BEW-FL

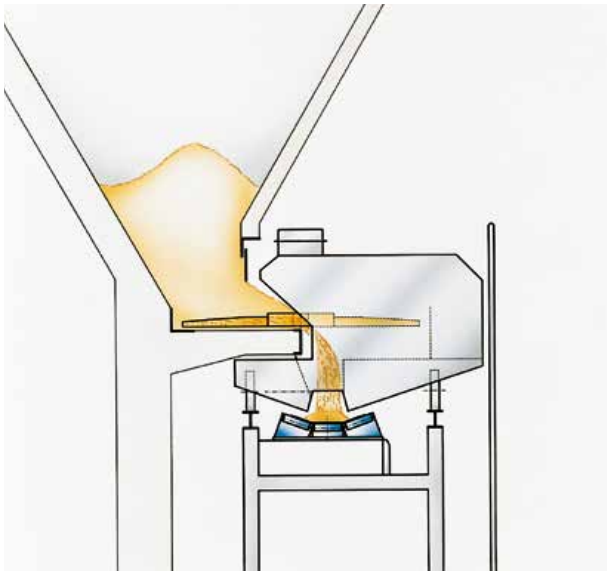

BEW with single sided discharge

Installed on the belt conveyor supporting structure, the Rotary Discharge Machine moves along the hopper shelf and reclaims the bulk material. The drive unit and electrical package are safely stored inside the dust-tight casing of the machine.



BEW with single swivel drive for single sided discharge

Installed on the belt conveyor supporting structure, the Rotary Discharge Machine travels to defined areas of the hopper where it reclaims the bulk material. A high speed mode in the travel drive allows to reach these areas quickly. The main drive with all its components forms a swivel unit installed on the trolley.



BEW with double swivel drive for single sided discharge on both sides

Installed on the belt conveyor supporting structure, the Rotary Discharge Machine travels to defined areas of the hopper. The discharge wheel swivels between the shelves on both sides of the hopper. A high speed mode in the travel drive allows to reach these areas quickly. The main drive with all its components forms a swivel unit installed on the trolley.



Rotary Discharge Machine type BEW-FL with weigh feeder

Raw material handling in a Cement Plant

Three Rotary Discharge Machines are installed underneath a row of hoppers storing a total of 9,000 t of limestone, marl and dolomite. In order to obtain the required mixture directly when reclaiming the different raw materials from the hoppers for subsequent mill feeding, the reclaim capacity of the three discharge machines is controlled by a Weigh Belt Feeder forming part of the mobile discharge machine.

The actual volume to be reclaimed by the discharge machine from the three hoppers is determined in the laboratory. Adequate adjustment of the total reclaim capacity is made in the mill control room. The mixture ratio remains unchanged.

On account of the homogeneous volumetric reclaim through the hopper openings, an accuracy of +/- 1% can be achieved with the Weigh Feeders.

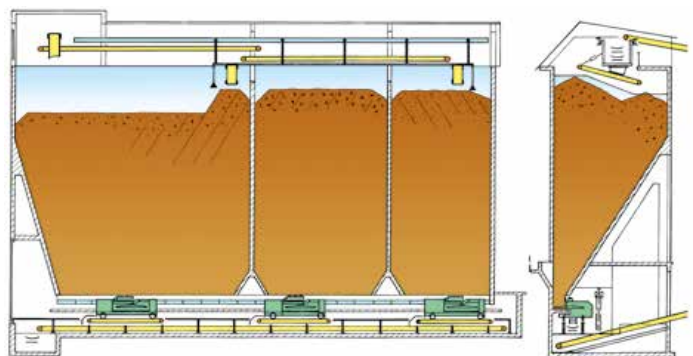

Storage capacity	9,000 t
Material	limestone and marl of 0 – 60 mm
Humidity	max. 14 %
Capacity of each discharge machine	30 – 180 t/h
Installed power	20 kW
Rotating speed of discharge wheels	adjustable from 0.5 to 5 rpm
Travel speed	1 and/or 0.45 m/min
Weigh belt feeder width	800 mm

Data sheet

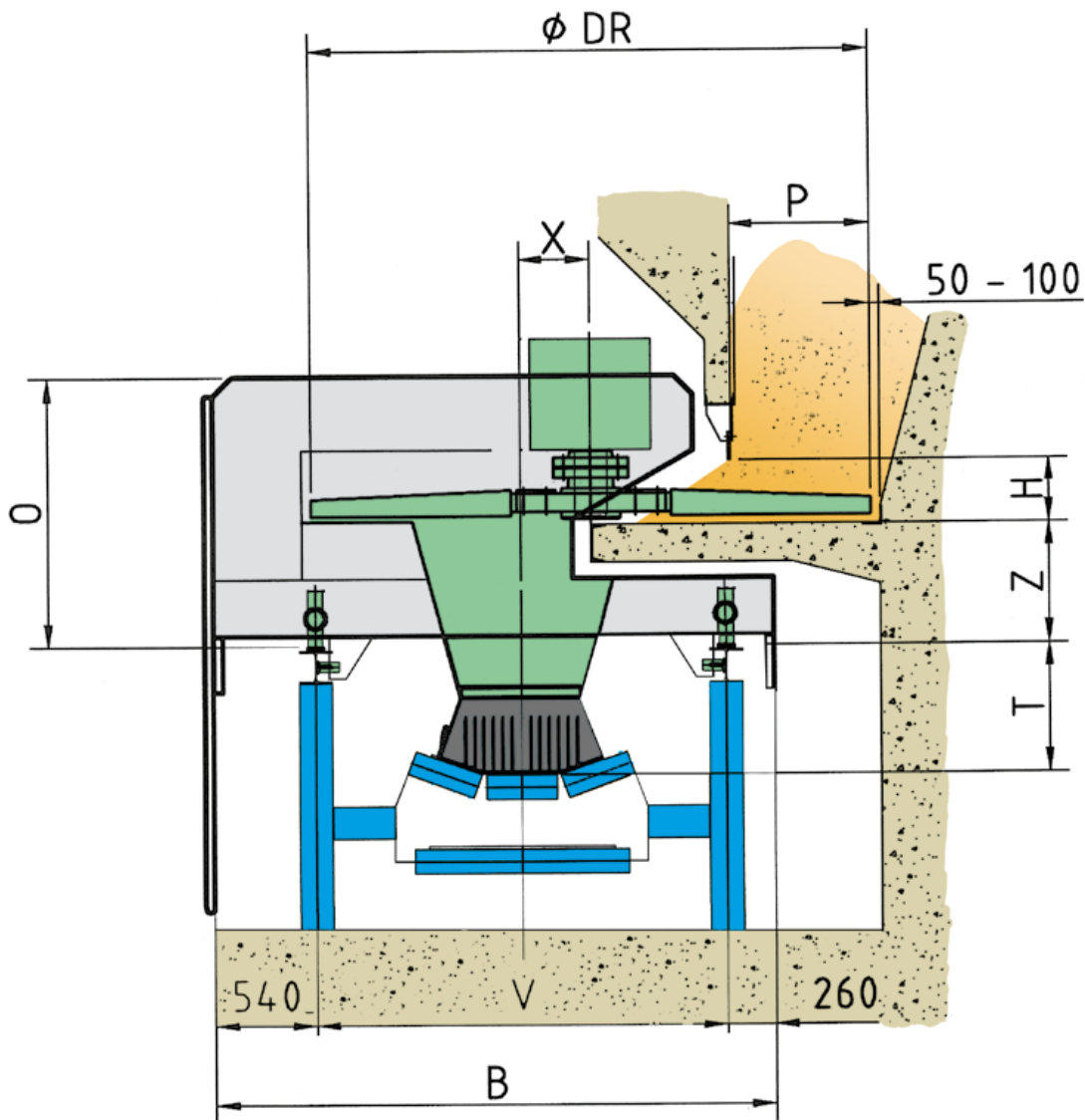

Rotary Discharge Machine - Low Profile Model

discharge wheel diameter	discharge opening height	penetration depth	overall width	overall height	track	hopper shelf to rail height	rail to belt feeder height	theoretical capacity Q (m ³ /h) single sided discharge with wheel speed n (rpm)				max. admissible travel speed
								range 1:10 circular speed at wheel tip				
								U = 0.3 m/s		U = 3.0 m/s		
(mm)	(mm)	(mm)	(mm)	(mm)	(mm)	(mm)	(mm)	(m ³ /h)	(rpm)	(m ³ /h)	(rpm)	(m/min)
DR	H	P	B	O	V	Z	T	U = 0.3 m/s	U = 3.0 m/s			V
(mm)	(mm)	(mm)	(mm)	(mm)	(mm)	(mm)	(mm)	(m ³ /h)	(rpm)	(m ³ /h)	(rpm)	(m/min)
2,000	200	400	2,300	1,450	1,500	600	500	47	(2.90)	470	(29.0)	6.35
2,500	250	450	2,650	1,500	1,850	650	550	69	(2.28)	690	(22.8)	6.35
3,000	300	700	3,000	1,600	2,200	650	700	112	(1.91)	1,120	(19.1)	6.35
3,500	350	800	3,300	1,700	2,500	700	750	151	(1.63)	1,510	(16.3)	6.35
4,000	400	1,000	3,600	1,850	2,800	750	800	151	(1.63)	2,050	(14.3)	6.35

Standard dimensions and capacity. Further dimensions and capacities on request.



Rotating Rotary Discharge Machine type BEW-K

For large silos with a 5 m to 12 m diameter

The discharge wheel undercuts the material column and guides the material to the central outlet chute.

- First in / First out
- Simultaneous feeding and discharge
- Proportional reclaim
- Easy access



Rotating Rotary Discharge Machine

Culley Power Station, Indiana – USA

In the coal-fired plant in Indiana the FGD-gypsum, a by-product of the flue gas desulphurisation process, is stored in concrete silos. With an average humidity of 8 – 10%, sometimes even 15%, the FGD-gypsum is a heavy and sticky material with poor flow characteristics. The exact data of this material were determined by tests carried out in the LOUISE laboratory and the reclaim of each silo is now performed with a rotating rotary discharge machine designed to suite the specific characteristics revealed by these tests.

Each machine reclaims a total of 500 t/h, a capacity reached within 15 seconds, and loads onto 20 ton trucks. With normal loading conditions, the material volume of each silo is unloaded within 8 hours. In order to provide easy access, the discharge machine bottom and outlet chute are fitted directly underneath the discharge arms. The bottom rotates with the discharge wheel and the machine may be entered from the side opposite to the discharge arms.

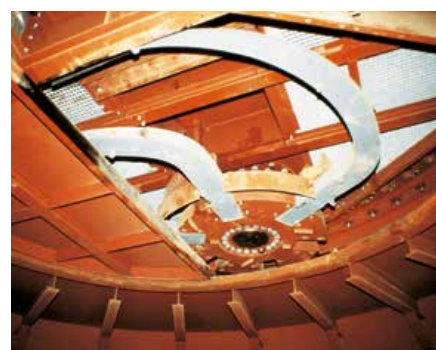

Storage capacity	2 silos of 1,000 m ³ each
Diameter of each silo	8 m
Height of each silo	20 m
Installed power	75 kW
Discharge capacity of each discharge machine	500 t/h
Rotating speed of discharge wheel	adjustable from 0.3 to 3 rpm
Diameter of discharge wheel	4,500 mm

Rotating rotary discharge machine type BEW-K

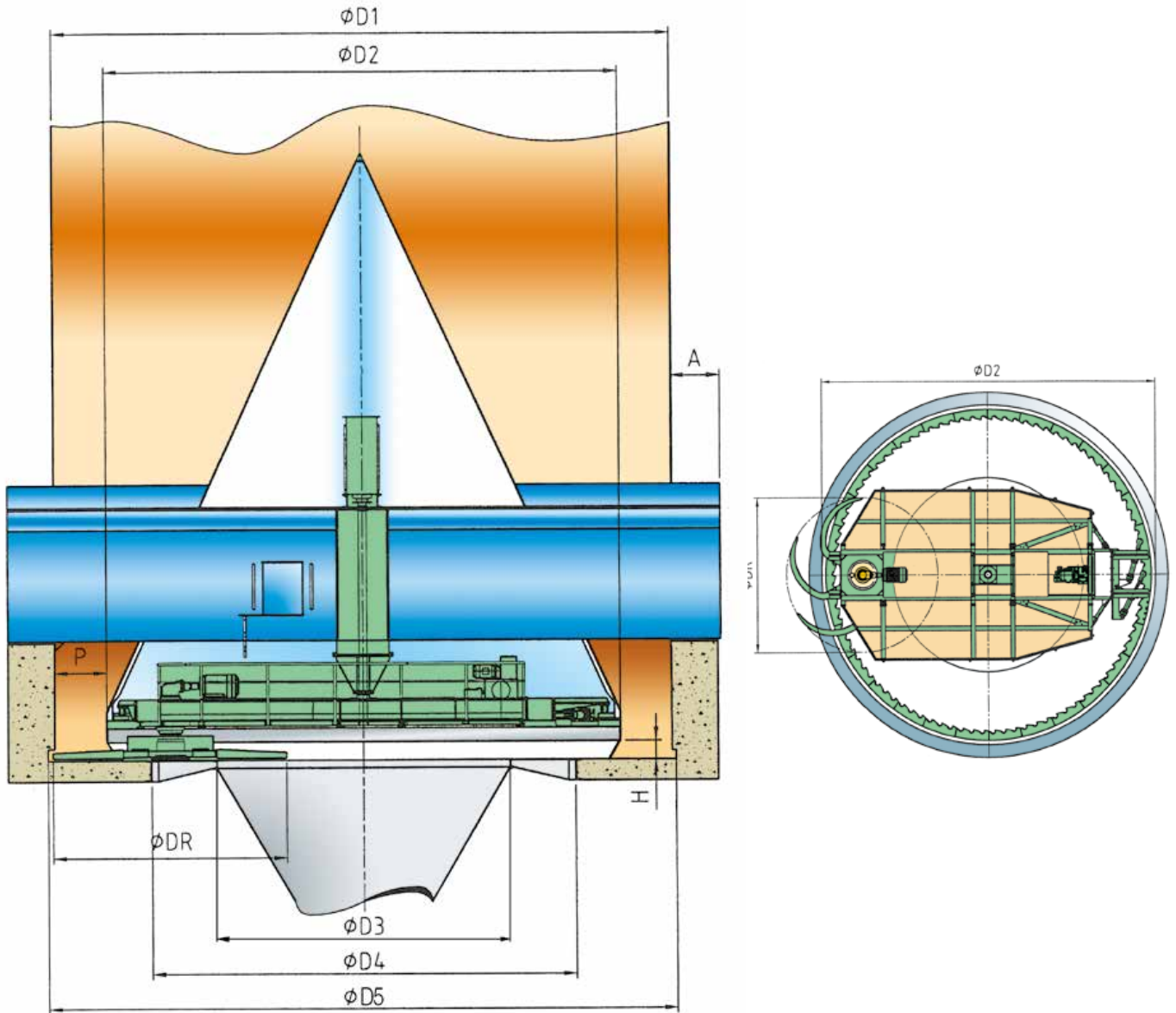

Rotating Rotary Discharge Machine type BEW-K

diameter silo	diameter discharge wheel	diameter cone	diameter floor ring opening	diameter concrete floor opening	diameter incl. undercut	max. protrusion of cone girder	discharge opening height	penetration depth	theoretical capacity Q (m ³ /h) with wheel speed n (rpm)			
									range 1:10 circular speed at wheel tip			
									U = 0.3 m/s		U = 3.0 m/s	
D1	DR	D2	D3	D4	D5	A	H	P	(m ³ /h)	(rpm)	(m ³ /h)	(rpm)
5,000	3,000	3,600	1,200	1,950	5,140	600	300	700	112	(1.91)	1,120	(19.1)
6,000	3,600	4,400	1,300	2,350	6,140	700	350	800	155	(1.67)	1,550	(16.7)
8,000	4,500	6,000	2,200	4,750	8,140	900	450	1,000	247	(1.27)	2,470	(12.7)
10,000	4,500	8,000	3,700	6,250	10,140	900	450	1,000	247	(1.27)	2,470	(12.7)
12,000	4,500	10,000	5,700	8,250	12,140	900	450	1,000	247	(1.27)	2,470	(12.7)

Standard dimension and capacity. Further dimensions and capacities on request.

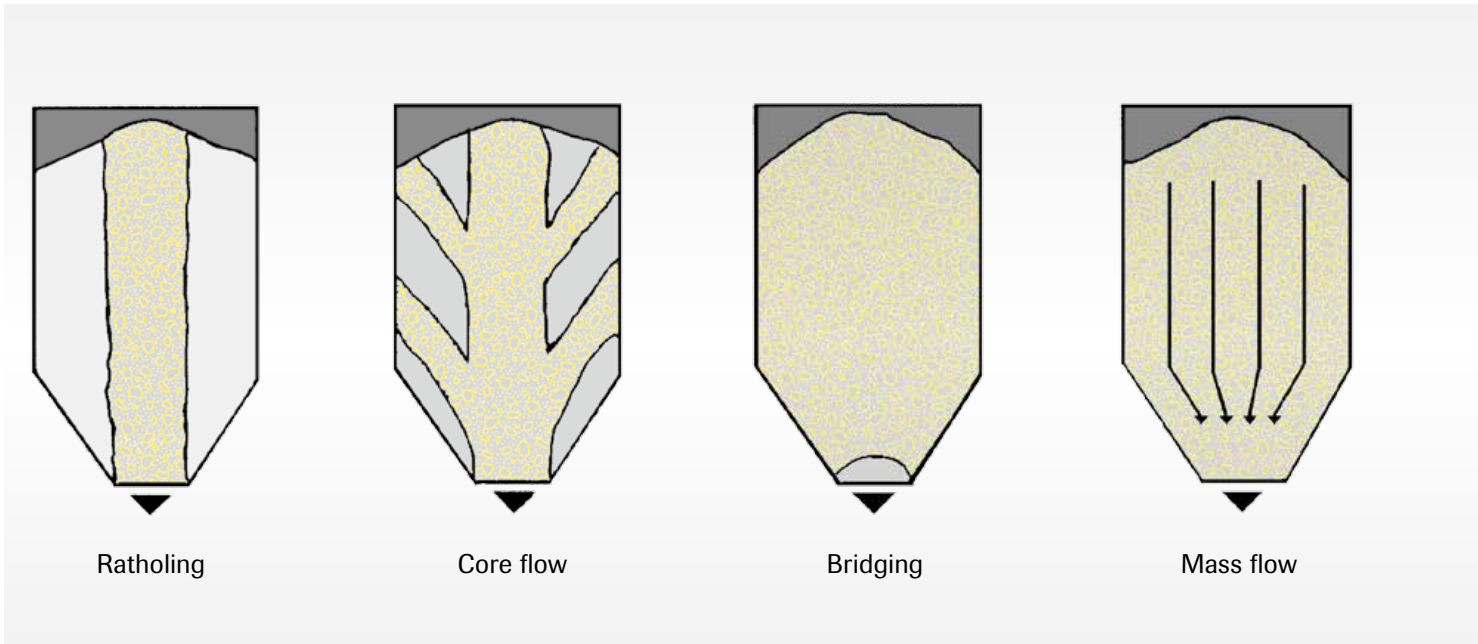

Bulk material testing in our laboratory

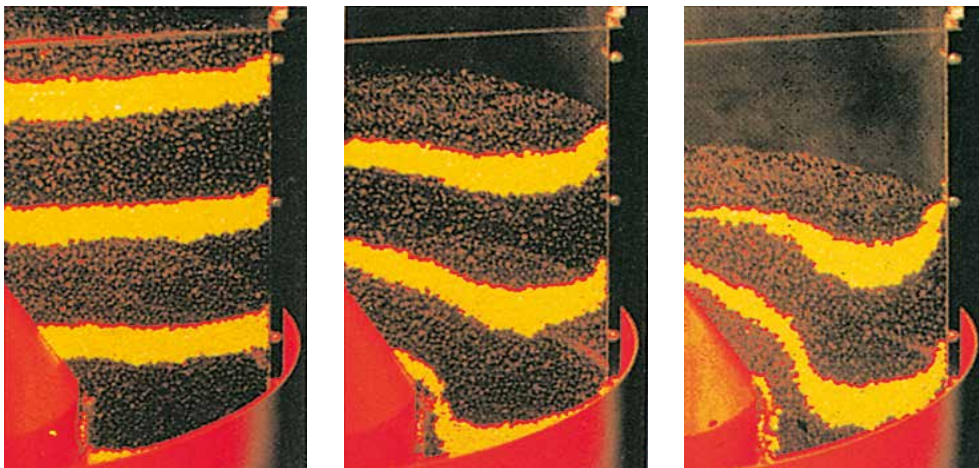

To determine the physical and mechanical properties and behaviour of specific bulk materials, our laboratory incorporates a large variety of testing equipment. Various test methods allow to determine the correct application of our products, e.g. shear testing.

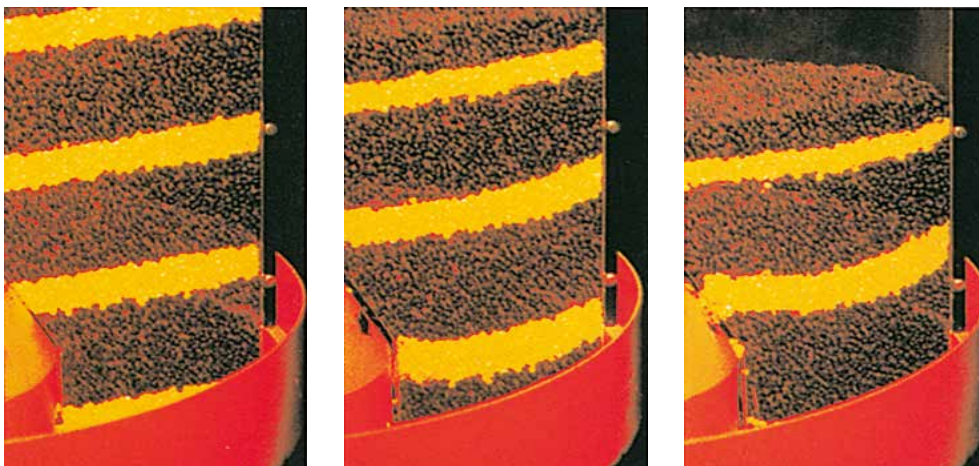

Bulk material tests



Jennicke shear cell

Components



5 BEW-K's 10,000/4,500 during assembly in the workshop



Block gear units for BEW-BL



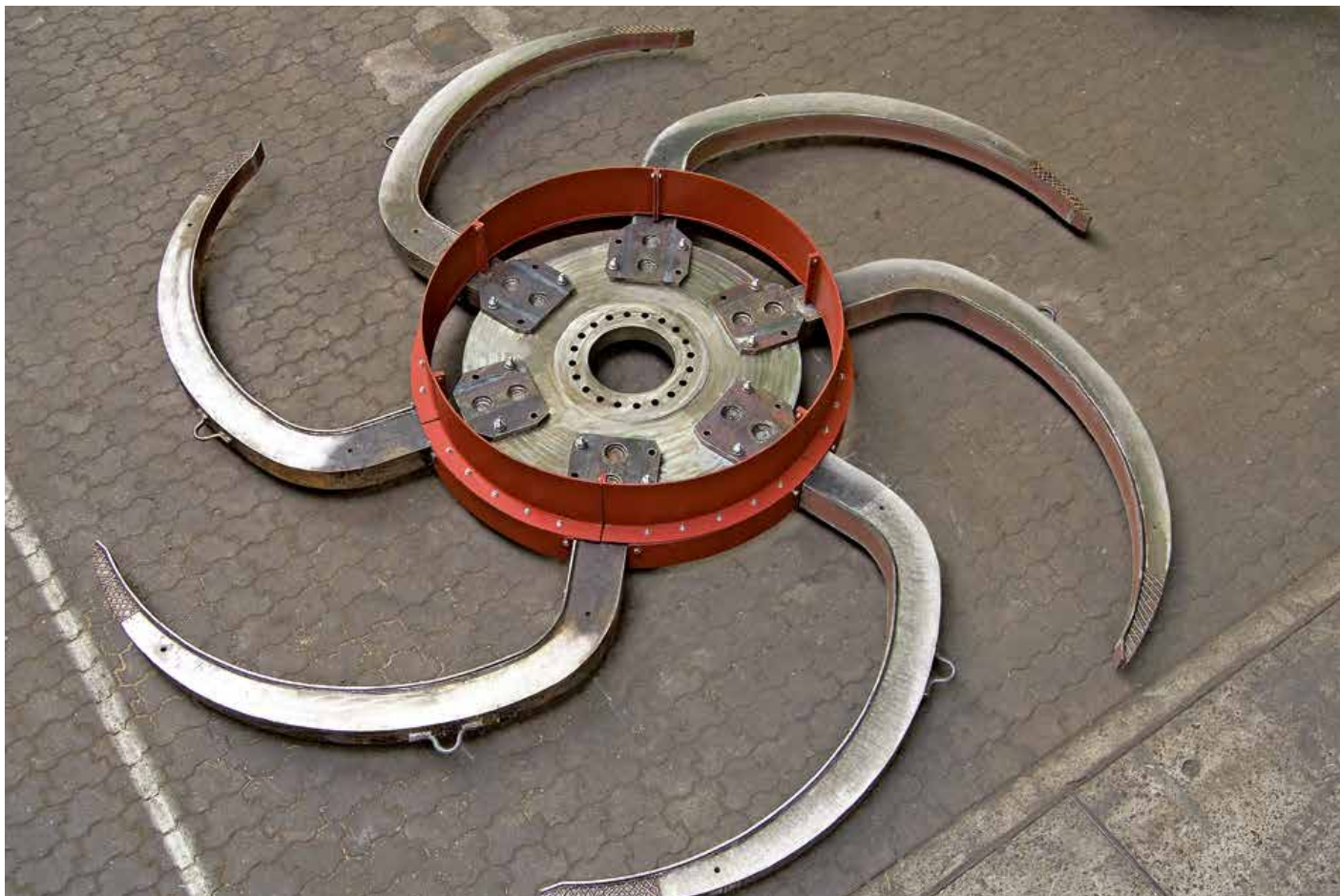

BEW-K discharge wheel, \varnothing 4,500 mm



Chassis of BEW-K, view onto hydraulic cylinders for rotation



Installation of new bucket strand

Conversions and Refurbishments

- Upgrading of existing plant components
- Targeting increased efficiency
- Higher output
- Improved availability

With our expert team of engineers planning selective modernisation measures, we pay special attention to the upgrading of existing plant components, targeting increased efficiency, higher output rates and improved availability.

Upgrading of your materials handling and storage equipment to state-of-the-art technology is achieved through a tailor-made refurbishment process under optimum utilisation of time and budget.

Most of the existing components are re-used in the refurbishment process to save cost.

Engineered conversions and refurbishments for increased efficiency and output are performed on AUMUND equipment as well as on the equipment of other manufacturers.



Pre-assembly of chain strands

www.ispm-service.com

PORTUGAL

+351 234 304 197
Rua Dr. Alberto Soares Machado, 89
Apartado 512, EC Avenida
3801-901 Aveiro | Portugal

ispm@ispm-service.pt

FRANÇA

+33 1 43 34 81 72
+33 6 11 10 50 91
5 Place Charras Apt 67
92.400 Courbevoie | France

drousseau@ispm-service.pt

BRASIL

+55 31 2527 4426
Três Corações, 136/1004
Belo Horizonte - MG
30411-239 | Brasil

dieter.dombrowski@ispm-service.pt

