



Screening and Processing



Drying System



Wood Yard



Conveying solutions in the cement industry



Maintenance and Service



Waste to Fuel



Waste to Flame



Waste to Electricity



Biomass Fuel Handling



Pneumatic Conveying

# INDUSTRIAL PROJECT AND SERVICE

[www.ispm-service.com](http://www.ispm-service.com)



A **ISPM** é uma empresa portuguesa que nasceu em 2015 com um conceito ambiental e inovador. Orientada por valores que incitam o desenvolvimento sustentável numa era industrializada, onde a geração de energia através de desperdício é, não só, uma forma de zelar pelo futuro do Planeta, mas também um meio lucrativo.

A **ISPM** é uma empresa flexível, entusiasta, socialmente responsável e adaptável às mudanças.

O nosso negócio é caracterizado principalmente por um esforço conjunto com os nossos parceiros.

Instalamos equipamentos, realizamos projetos **turn-key** e dispomos de assistência técnica com profissionais motivados e altamente qualificados. A superação de desafios, a busca pela geração e implementação de soluções tecnológicas, negócios inovadores e *out-of-the-box*, fazem parte do nosso dia-a-dia e da nossa visão a longo prazo. Somos uma empresa visionária, trabalhamos hoje para o amanhã como início do futuro.

Paulo Teixeira

A SOLUÇÃO DO  
FUTURO NO  
PRESENTE







**A ISPM é distribuidor exclusivo da:**

*BMH Technology* em Portugal e França;  
*Jeffrey Rader, Stela e Aumund* em Portugal;  
*Demuth* em Portugal, Espanha e França;  
E revendedor autorizado da *BMH* no Brasil.







## Drying System

Existem ainda em funcionamento sistemas de secagem antigos com um alto consumo energético. Considerando apenas os de menor consumo que ainda são de 1,5 kWh ou mesmo 2,0 kWh por kg de água evaporada. Em contrapartida, a maioria dos nossos sistemas actuais tem um baixo consumo de energia inferior a 1,0 kWh / kg de água evaporada.



A melhoria constante dos secadores Stela permite oferecer equipamentos com um consumo de energia de 0.4Kwh/ Kg de água evaporada.

**Indústria agrícola**

**Indústria de painéis de madeira**

**Indústria de celulose e papel**

**Indústria de pellets**

**Indústria de cimento**

**Produção de energia através da  
biomassa florestal**

**Indústria alimentar**

**Comida para animais de estimação**

**Indústria de tratamento de resíduos**





# Low-temperature belt drier



Mondi Frantschach GmbH  
Type: BT 1/6200-42  
Product: bark  
Drying capacity: 26,4 t/h from 53% to 37%  
Year: 2011

Quellenangabe „Holzkurier/Schnaubelt“



## STELA - Low-temperature belt drier

STELA is a mid-sized family-owned enterprise in third generation with an experience of more than 40 years in the technology of low-temperature drying.

### A technically mature solution

#### Plant performance increased by using a belt drier

At Mondi Frantschach in St. Gertraud, Austria, capacity in the bark boiler - installed in 1981 - was getting tight. For this reason, the company searched for new ways to increase its in-house energy supply, in order to raise the amount of high-pressure steam generated while still using the existing plant. The decision was made to use a belt drier from Stela Laxhuber of Massing, Germany, in which the biomass would first be predried. This would increase the efficiency of the fuel and increase the boiler performance in turn.

Since maintenance work had always been conducted properly, the existing bark boiler at Mondi Frantschach was in a good condition. Nonetheless, it was operating to capacity on the flue gas side. "The flue gas speed for the boiler was too high. A new investment would have meant very high costs. Therefore, we needed a way to reduce the amounts of flue gas coming out of the boiler so we could produce more high-pressure steam", says Project Manager Günther Leitner about the original situation. For this reason, we decided to invest in a bark predrier, so that the bark would already have the water removed from it in advance, thus increasing its calorific value.

#### Mature plant technology

Since bark predriers are the exception in Europe, in the beginning, it was no easy task for the Project Manager to locate a suitable supplier. What was decided upon relatively quickly was the idea to use a belt drier. "The plant technology offered by Stela Laxhuber persuaded us with its maturity", relates Stefan Raffalt, who is also familiar with the project. "This Bavarian company was able to offer us the best cost/performance ratio." The company, founded in 1922, can also point to some fantastic reference plants it has already worked on, as those in St. Gertraud found out. At the end of November, the Stela belt drier began operations at the company's site in the state of Carinthia.

At Mondi Frantschach, the energy required for the bark drier is obtained from waste heat. "If you have heat already available for free, as we do, then that's the best possible solution", says Leitner. After the drier had been running for three months, the first results were in St. Gertraud. Reports from Mondi Frantschach indicate that "the project's objective of producing more high-pressure steam from the bark boiler has already been achieved, and the values guaranteed by Stela Laxhuber were adhered to". Inside the plant, the dry bark content was increased from 50 to 63%. The belt drier has a water evaporation rate of 9 t/h. In addition, the 50m long belt drier is designed to use multi-vent technology. This provides the belt drier with slow-running, high-volume fans, which increase drying speed. Thus the drying speed is increased and, the same time power consumption and noise emissions are reduced. "This second factor was also an important argument in awarding the contract to Stela Laxhuber", emphasises Raffalt. So you can hardly hear that the drier is running, even when standing right in front of it.

#### A successful partnership

In St. Gertraud, they are extremely happy about their successful partnership with the Bavarian drier specialists. "We are very satisfied with work of Stela Project Manager Tobias Latein and his team. Even though Stela Laxhuber did not yet have that much experience in the area of bark predrying, with the outstanding joint-expertise of the project team from Mondi Frantschach and Stela Laxhuber, we were able to achieve a result which was satisfactory for all concerned. This drying technology is a mature solution", underlines Raffalt. "The investment allowed us to increase the efficiency of our existing system".

Indication of source: Holzkurier 3rd of March 2011

#### Project objective achieved

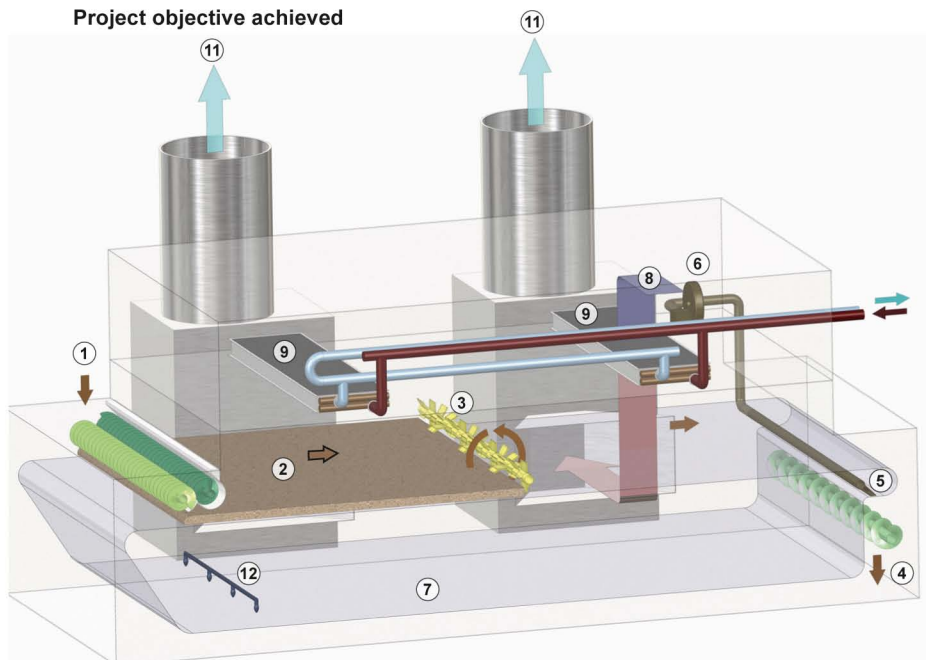

- 1 = feeding station
- 2 = product
- 3 = turning device
- 4 = discharge screw
- 5 = belt cleaning system (dry)
- 6 = fan for belt cleaning system
- 7 = web belt
- 8 = fresh air
- 9 = heat exchanger
- 10 = heat supply and return
- 11 = exhaust air
- 12 = wet cleaning



# Stela low-temperature belt dryer

Stela is a medium-size family-owned enterprise with more than 45 years of experience in drying technology. More than 3500 driers were installed all over the world, whereof over 140 belt driers are used for the drying of biomass.



- By means of fuel predrying, the capacity of the boiler is increased up to 20 %
- Available waste heat sources like e.g. hot air, low-pressure steam or hot water of different temperatures serve for hot air generation
- Adaption and alteration works do not cause a long downtime of the boiler

## References

### **Mondi Frantschach GmbH (Austria)**

Dryer type: BT 1/6200-42  
Product: bark

Uptime: 8500 h/a  
Water evaporation: 9 t/h  
Moisture content: 53 % / 37 %  
Drying temperature: approx. 74°C  
Thermal power: 13.200 kW  
Operating since October 2010

### **Södra Cell Mönsterås (Sweden)**

Dryer type: BT 1/6200-49.5  
Product: softwood bark and other  
wood residues

Uptime: 8500 h/a  
Water evaporation: 10 t/h  
Moisture content: 60 % / 45 %  
Drying temperature: approx. 72°C  
Thermal power: 13.000 kW  
Commissioning in May 2012

### **Arauco (Chile)**

Dryer type: BT 1/6200-61.5  
Product: woodchips, shavings, bark,  
sawdust

Uptime: 8500 h/a  
Water evaporation: 19 t/h  
Moisture content: 64 % / 49.1 %  
Drying temperature: approx. 100°C  
Thermal power: 20.600 kW  
Commissioning in May 2012





# Low temperature belt dryer for wooden biomass





# Low temperature belt dryer for biomass

## STELA Laxhuber GmbH

We are an internationally orientated company that has been successful in its activities in the drying of biomass products on belt dryers - we were active in this sector from the beginning and have had a defining impact on the development of technology with low-calorific heat for this sector.

Today we are market leader with more than 140 low-temperature belt dryers in operation worldwide.

## Technical specifications

- Output ranges of up to 50 t water evaporation/h realised
- Total output of the lines for sawdust drying corresponds to an annual production of 5,000,000 t pellets
- Total water capacities of 5.3 million tons per year thus far
- Own production facilities with continuous quality control by qualified and trained STELA employees

## Belt dryers are used in a wide range of industrial branches and product divisions:

- Pellet industry
- Wood glazing
- Biomass to liquid (BTL)
- Wood products industry
- Pulp and paper industry
- Sawmills
- Biomass power plants

In addition to conventional (wooden) biomass, STELA belt dryers can also dry the following products: Coal pellets, pulp, straw, garden waste, pomace and much more.



Bark



Sawdust

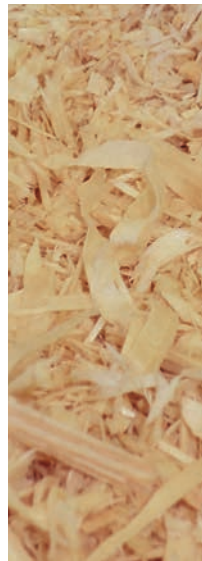

Wood shavings



Wood chips



OSB-Strands



## Heat sources

The greatest benefit of the belt dryer is its use of low-temperature heat sources, which are frequently available as waste heat.

- It makes sense to use heat sources with low temperatures from 30°C in the belt dryer
- With the use of multi-stage heating circuits, various heat sources can be combined in the belt dryer

Conventional (typical) heat sources include (are):

- Hot water from cogeneration
- Hot water from flue gas condensation
- Low-pressure steam
- Waste heat from paper production

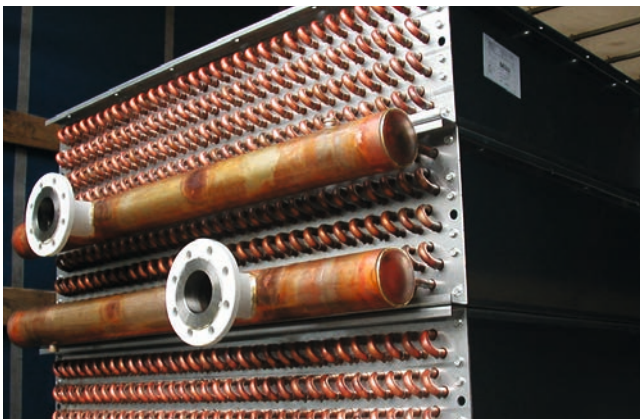



# Construction

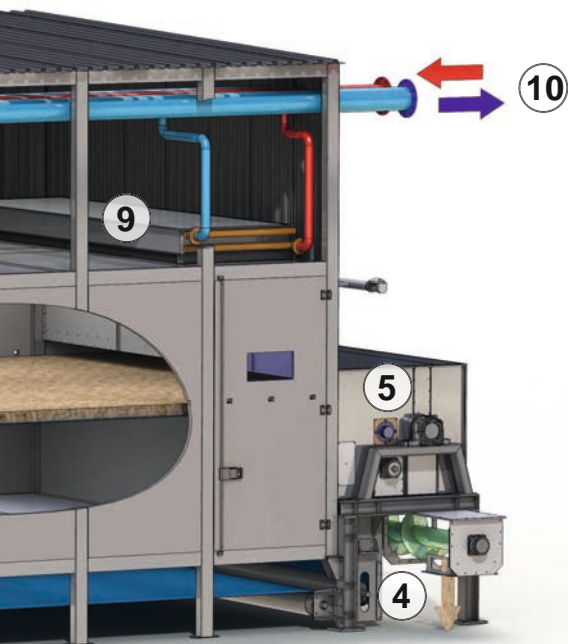
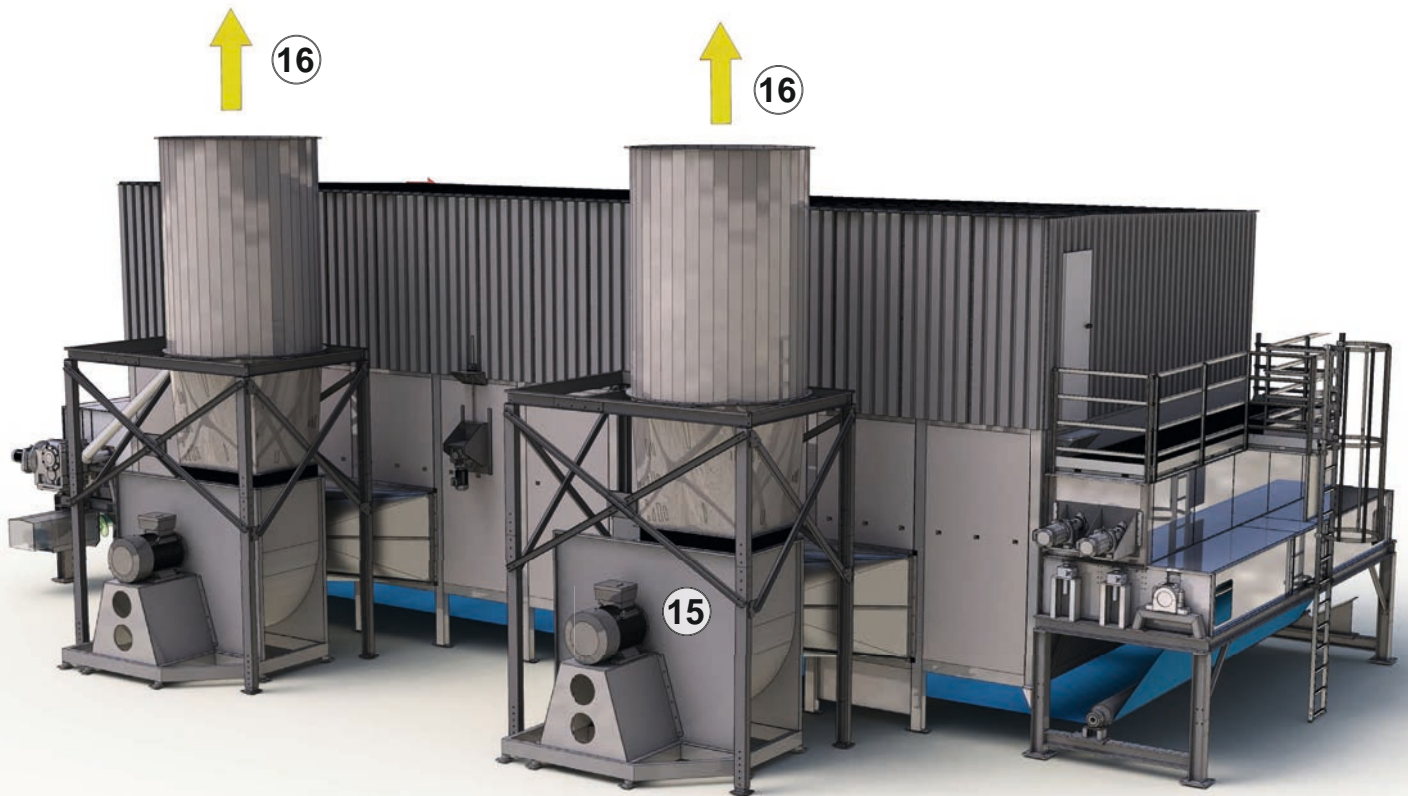

- 1 = feeding station
- 2 = product layer
- 3 = turning device
- 4 = discharge screw
- 5 = belt cleaning system (dry)
- 6 = fan for belt cleaning system
- 7 = web belt
- 8 = belt cleaning system (wet)
- 9 = heat exchanger
- 10 = heat supply

- 11 = fresh air intake
- 12 = fresh air
- 13 = heated air
- 14 = exhaust air
- 15 = exhaust air fan
- 16 = exit air
- 17 = belt alignment
- 18 = access housing for heat generation
- 19 = door for inspection



### Characteristic features of our dryer lines

- Product turning device for an uniform final moisture and energy-saving ventilation of the product
- Multivent system with multiple directly coupled, low-noise radial fans for continuous air distribution with minimal pressure loss and noise emissions
- Guaranteed low dust emission values in accordance with the German Pollution Control Act (BImSchG)
- Modular line system, which can be easily expanded at a later time
- Low thermal and electrical consumption values by optimally synchronized components
- Design in three various belt widths for individual adaptation according to customer requirements
- Inspection doors for easy access to dryer inside
- Insulated dryer body
- A closed construction enables outdoor installation at temperatures down to -40°C and beyond.

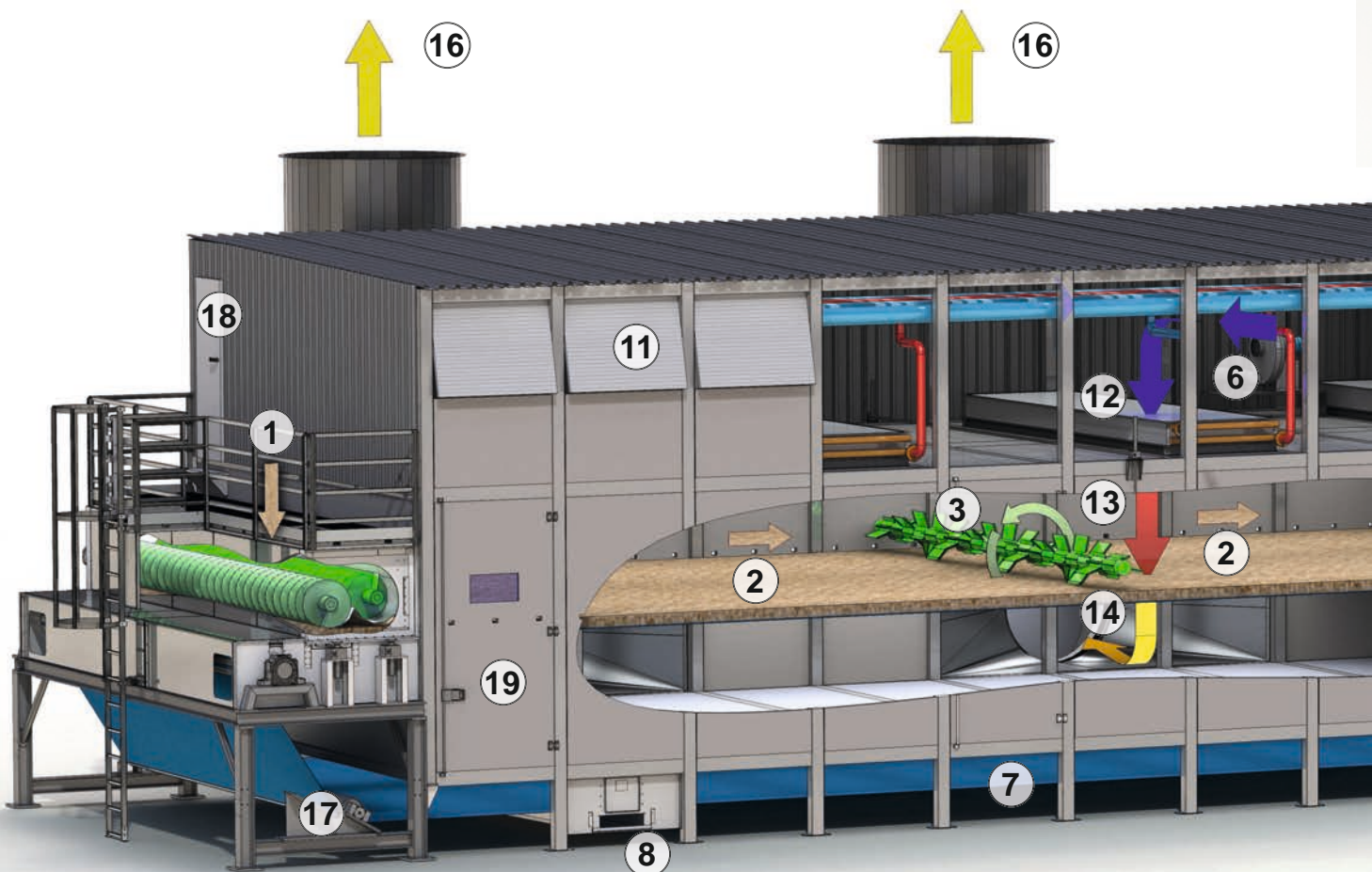



## Qualität – Made in Germany

The core of our philosophy is own production. In order to react flexibly to customer requests, meet with customer lead time best we offer our wide range of production. Our production process begins with the raw material, which is processed with CNC-controlled machine tools. A particular feature of the production is the low-weld construction, which enables a long construction type of the drying lines. The materials which are used are stainless steel, aluminium and galvanised material - which makes subsequent painting as anti-corrosion protection entirely unnecessary.

Service is a major emphasis at our company. Since our customers are production operations, shut-downs cost money. Problems are solved by a mobile service team - whether by telephone or on-site visits. This is an additional advantage of our production depth: necessary spare parts can be provided immediately.

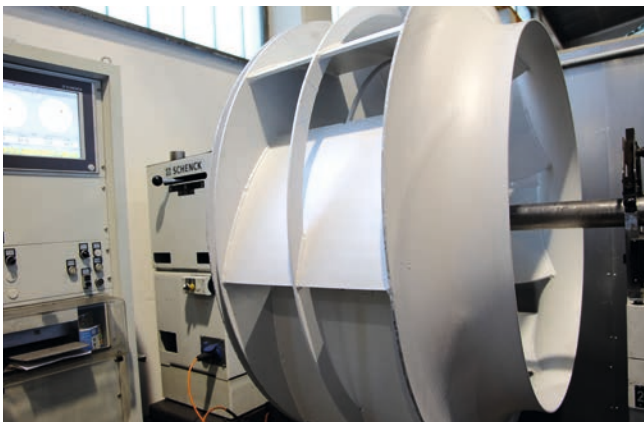



## Control technology

With our own control and electrical department, we can flexibly address customer requirements. With the highest quality claim, we offer you a broadly diversified portfolio of electrical engineering, automation technology, process visualisation, maintenance, switchgear construction and electronic MSR assembly from one location. Based on our ambition quality standards,....

Our services include: Set-up and wiring of EMC-appropriate switchgears; power distribution; low-voltage distribution up to 3200 A; measurement, regulating and control cabinets; PLC and PLS cabinets, control and display panels; production in accordance with DIN/VDE, EN; equipment of the lines according to ATEX; tailored implementation of customer requests; conversion and expansion of switchgears; compensation systems...

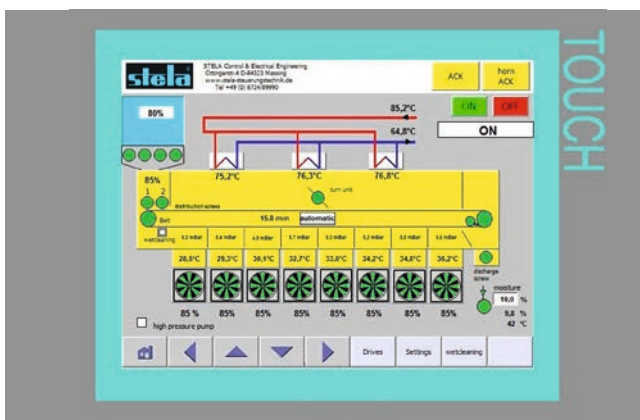



## Worldwide references



Project: Södra Cell  
Sweden  
Type: BT 1/6200-49,5  
Product: Bark



Project: Graanul Invest  
Estonia  
Type: 2x BT 1/6200-30  
Product: Sawdust



Project: BIOENER  
Uruguay  
Type: BT 1/6200-48  
Product: Sawdust and Wood chips



Worldwide references



Project: Arauco  
Chile  
Type: BT 1/6200-61,50  
Product: Bark



Project: Mondi Frantschach GmbH  
Austria  
Type: BT 1/6200-42  
Product: Bark



Project: RWE/German Pellets  
Germany  
Type: BT 1/6200-48  
Product: Sawdust



## Worldwide references



Project: Nature's Flame  
New Zealand  
Type: BT 1/6200-52,5  
Product: Sawdust



Project: Ruderatshofen Futtertrocknung e. G.  
Germany  
Type: BT 1/6200-33  
Product: Wood chips, Bark, Grass, Straw



Project: Stelmet  
Poland  
Type: BT 1/6200-30 and BT 1/6200-24  
Product: Sawdust



Worldwide references



Project: Pfeifer Holz GmbH  
Germany  
Type: 4x BT 1/6200-36  
Product: Sawdust



Project: German Pellets  
Germany  
Type: 2x BT 1/6200-22,5  
Product: Sawdust



Project: Imal  
Italy  
Type: BT 1/6200-43,5  
Product: OSB-Strands



reference list

low temperature belt dryer for wooden biomass





Project: I-PAN  
Italy, Coniolo  
Type: BT 1/6200-43,5  
Year: 2012  
Product: OSB-Strands  
Dryer output capacity:  
9,6 t/h from 56,8% - 3%



Project: Södra Cell  
Sweden, Mönsterås  
Type: BT 1/6200-49,5  
Year: 2012  
Product: bark  
Dryer output capacity:  
26,6 t/h from 60% - 45%







Project: Ante Holz  
GmbH & Co KG  
Germany, Rottleberode  
Type: BT 1/6200-15  
Year: 2012  
Product: sawdust  
Dryer output capacity:  
5,0 t/h from 50% - 10%



Project: S.C. Holzindustrie  
Schweighofer  
S.R.L. Rumania, Radauti  
Type: BT 1/6200-58,5  
Year: 2012  
Product: sawdust  
Dryer output capacity:  
17,0 t/h from 50% - 10%



Project: Dalkia UK,  
Great Britian, Chilton  
Type: BT 1/2700-13  
Year: 2012  
Product: wood chips  
Dryer output capacity:  
7,0 t/h from 22,5% - 10%



Project: SIA Graanul Invest  
Latvia, Ezerini  
Type: 2x BT 1/6200-30  
Year: 2012  
Product: sawdust  
Dryer output capacity:  
per 8,5 t/h from 50% - 10%





Project: Juwi Bio GmbH  
Germany, Bad Arolsen  
Type:  
BT 1/6200-15 (down)  
BT 1/6200-9 (above)  
Year: 2012  
Product: sawdust  
Dryer output capacity:  
4,4 t/h from 50% - 10% (down)  
2,5 t/h from 50% - 10% (above)



Project: Juwi Bio GmbH  
Germany, Dotternhausen  
Type: BT 1/6200-19,5  
Year: 2012  
Product: sawdust  
Dryer output capacity:  
6,7 t/h from 47% - 9%



Project: Arauco  
Chile, Valdivia  
Type: BT 1/6200-61,5  
Year: 2012  
Product: bark  
Dryer output capacity:  
46,0 t/h from 64% - 49%



Project: Mayr-Melnhof  
Czech Republic, Paskov  
Type: BT 1/6200-28,5  
Year: 2012  
Product: sawdust  
Dryer output capacity:  
10,0 t/h from 50% - 10%





Project: University of  
British Columbia Canada,  
Vancouver  
Type: BT 1/2700-14  
Year: 2012  
Product: wood chips  
and bark  
Dryer output capacity:  
2,1 t/h from 50% - 25%



Project: Ponlar Sa  
Uruguay, Rivera  
Type: BT 1/2700-12  
Year: 2012  
Product: sawdust  
Dryer output capacity:  
1,8 t/h from 55% - 15%



Project: BioEnergio s.r.o.  
Slovakia, Ruzomberko  
Type: 2x BT 1/6200-27  
Year: 2012  
Product: sawdust  
Dryer output capacity:  
6,5 t/h from 50% - 10%



Project: AGO AG  
Germany, Wunsiedel  
Type: BT 1/6200-12  
Year: 2012  
Product: sawdust  
Dryer output capacity:  
3,5 t/h from 50% - 10%





Project: Hekotek  
Estonia, Jüri  
Type: BT 1/6200-34,5  
Year: 2011  
Product: sawdust  
Dryer output capacity:  
12,0 t/h from 53% - 11%



Project: Moderator d.o.o  
Croatia, Udbina  
Type: BT 1/6200-13,5  
Year: 2011  
Product: sawdust  
Dryer output capacity:  
5,0 t/h from 45% - 10%



Project: Graanul Invest  
Estonia, Helme  
Type: 2x BT 1/6200-30  
Year: 2011  
Product: sawdust  
Dryer output capacity:  
per 8,5 t/h from 50% - 10%



Project: BioEner  
Uruguay, Riviera  
Type: BT 1/6200-48  
Year: 2011  
Product: sawdust and  
wood chips mixture  
Dryer output capacity:  
21,0 t/h from 50% - 20%





Project: Sägewerk  
Schwaiger  
Germany, Hengersberg  
Type: BT 1/6200-33  
Year: 2011  
Product: sawdust  
Dryer output capacity:  
10,0 t/h from 50% - 10%



Project: EKO Energy GmbH  
Germany, Rothenburg/OL  
Type: 2x BT 1/6200-22,5  
Year: 2011  
Product: sawdust  
Dryer output capacity:  
per 7,5 t/h from 50% - 10%



Project: Ets JUNG Albert  
France, Berling  
Type: BT 1/2700-8  
Year: 2011  
Product: sawdust  
Dryer output capacity:  
1,2 t/h from 50% - 10%



Project: Kokapas trades  
Grupa Lativa, Bērzaune  
Type: BT 1/6200-12  
Year: 2011  
Product: sawdust  
Dryer output capacity:  
4,0 t/h from 50% - 10%





Project: Loher Raumexklusiv GmbH, Germany  
Wallersdorf- Haidlfing  
Type: BT 1/6200-12  
Year: 2011  
Product: sawdust  
Dryer output capacity: 3,2 t/h from 50% - 10%



Project: Aboltina buvuznemums AG Ltd.  
Latvia, Madonas  
Type: BT 1/6200-16,5  
Year: 2011  
Product: sawdust  
Dryer output capacity: 3,6 t/h from 50% - 3%



Project: Mondi  
Frantschach GmbH  
Austria, St. Gertraud  
Type: BT 1/6200-42  
Year: 2010  
Product: bark  
Dryer output capacity:  
26,4 t/h from 53% - 37%



Quellenangabe „Holzkurier/Schnaubelt“

Project: Energiepellets  
Germany, Hosenfeld  
Type: BT 1/6200-18  
Year: 2010  
Product: sawdust  
Dryer output capacity:  
5,5 t/h from 50% - 10%





Project: Baust Holzbetriebe  
Germany, Eslohe-Bremke  
Type: BT 1/2700-11  
Year: 2010  
Product: sawdust  
Dryer output capacity:  
1,6 t/h from 50% - 10%



RWE Erndtebrück  
Germany, Erndtebrück  
Type: BT 1/6200-48  
Year: 2010  
Product: sawdust  
Dryer output capacity:  
17,5 t/h from 50% - 10%



Project: German Pellets  
Germany, Wismar  
Type: 2x BT 1/6200-22,5  
Year: 2010  
Product: sawdust  
Dryer output capacity:  
per 6,5 t/h from 50% - 10%



Project: EVO  
Energieversorgung  
Offenbach AG  
Germany, Offenbach  
Type: BT 1/6200-19,5  
Year: 2010  
Product: sawdust  
Dryer output capacity:  
6,0 t/h from 50% - 9%





Project: Torkapparater  
Sweden, Stockholm  
Type: BT 1/6200-19,5  
Year: 2009  
Product: sawdust  
Dryer output capacity:  
12,2 t/h from 50% - 26%



Project: Bioenergie  
Aschaffenburg  
Germany, Aschaffenburg  
Type: BT 1/6200-18  
Year: 2009  
Product: sawdust  
Dryer output capacity:  
5,8 t/h from 50% - 10%



Project: Sägewerk  
Schwaiger  
Germany, Hengersberg  
Type: BT 1/6200-9  
Year: 2009  
Product: sawdust  
Dryer output capacity:  
2,8 t/h from 50% - 10%



Project: Bayerwald Pellet  
Germany, Regen  
Type: Extension from  
BT 1/2700-10 to  
BT 1/2700-16  
Year: 2009  
Product: sawdust  
Dryer output capacity:  
2,1 t/h from 50% - 10%





Project: Schweighofer  
Rumania, Sebes/Alba  
Type: Extension from  
BT 1/6200-25,5 to  
BT 1/6200-37,5  
Year: 2009  
Product: sawdust  
Dryer output capacity:  
11,6 t/h from 50% - 10%



Project: Compactec  
(Intrinergy)  
Germany, Straubing  
Type: BT 1/6200-19,5  
Year: 2009  
Product: sawdust  
Dryer output capacity:  
7,5 t/h from 50% - 10



Project: H. u. H. Pellets  
Austria, Stainach  
Type: BT 1/6200-15  
Year: 2009  
Product: sawdust  
Dryer output capacity:  
6,0 t/h from 50 % - 10%



Project: ECB mbH  
Germany, Heidelberg  
Type: BT 1/6200-30  
Year: 2009  
Product: sawdust  
Dryer output capacity:  
8,0 t/h from 50% - 9%





Project: Ameco Rumania,  
Gheorgheni  
Type: BT 1/6200-16,5  
Year: 2009  
Product: sawdust  
Dryer output capacity:  
6,0 t/h from 50% - 10%



Project: Nature's Flame  
New Zealand, Taupo  
Type: BT 1/6200-52,5  
Year: 2009  
Product: sawdust  
Dryer output capacity:  
12,0 t/h from 60% - 10%



Project: Barlinek GZRM  
Ukraine, Winniza  
Type: BT 1/6200-12  
Year: 2008  
Product: sawdust  
Dryer output capacity:  
4,4 t/h from 50% - 10%



Project: Tartak – „Olczyk“  
Poland, Krasocin  
Type: BT 1/6200-28,5  
Year: 2008  
Product: sawdust  
Dryer output capacity:  
8,0 t/h from 50% - 10%





Project: Stora Enso Timber  
Sweden, Grums  
Type: BT 1/6200-36  
Year: 2008  
Product: sawdust  
Dryer output capacity:  
10,0 t/h from 52% - 10%



Project: BEN BioEnergie  
Germany, Buchholz  
Type: BT 1/6200-25,5  
Year: 2008  
Product: sawdust  
Dryer output capacity:  
8,0 t/h from 48% - 8%



Project: Stora Enso  
Russia, Nebolchi  
Type: BT 1/6200-12  
Year: 2008  
Product: sawdust  
Dryer output capacity:  
3,6 t/h from 50% - 10%



Project: Pelletproduktion  
Sachsen-Anhalt Süd  
Germany, Heidegrund  
Type: BT 1/6200-30  
Year: 2008  
Product: sawdust  
Dryer output capacity:  
9,5 t/h from 50% - 10%





Project: WestPellets  
Germany, Titz-Ameln  
Type: BT 1/2700-13  
Year: 2008  
Product: sawdust  
Dryer output capacity:  
1,6 t/h from 50% - 10%



Project: Stelmet  
Poland, Jeleniow  
Type: BT 1/6200-30 and  
BT 1/6200-24  
Year: 2007/2008  
Product: sawdust  
Dryer output capacity:  
10,0 t/h & 8,0 t/h  
from 50% -10%



Project: Krekula & Lauri  
Sweden, Tärendö  
Type: BT 1/2700-14  
Year: 2008  
Product: sawdust  
Dryer output capacity:  
2,0 t/h from 50% - 10%



Project: Trocknung  
Ruderatshofen  
Germany, Biessenhofen  
Type: BT 1/6200-33  
Year: 2007/2008  
Product: wood chips,  
bark, gras, straw  
Drying capacity:  
8,0 - 10,0 t/h  
Water Evaporation





Project: Pröbstl Germany,  
Fuchstal  
Type: BT 1/6200-22,5  
Year: 2007  
Product: sawdust  
Dryer output capacity:  
8,0 t/h from 50% - 10%



Project: Finvest Croatia,  
Gerovo  
Type: BT 1/6200-10,5  
Year: 2007  
Product: sawdust  
Dryer output capacity:  
3,6 t/h from 50% - 13%



Project: HVT GmbH  
Germany, Dittersdorf  
Type: BT 1/6200-10,5  
Year: 2007  
Product: sawdust  
Dryer output capacity:  
3,6 t/h from 50% - 10%



Project: EPC GmbH  
Germany, Torgau  
Type: 2x BT 1/6200-28,5  
Year: 2007  
Product: sawdust  
Dryer output capacity:  
2 x 9,0 t/h from 50% - 10%





Project: Pfeifer Holz GmbH  
Germany, Uelzen  
Type: 2x BT 1/6200-33  
Year: 2007  
Product: sawdust  
Dryer output capacity:  
30,0 t/h from 42% - 3%



Project: German Pellets  
Germany, Herbrechtingen II  
Type: 2x BT 1/6200-22,5  
Year: 2007  
Product: sawdust  
Dryer output capacity:  
per 6,5 t/h from 50% - 10%



Project: Mayr-Melnhof  
Austria, Leoben  
Type: BT 1/6200-22,5  
Year: 2007  
Product: sawdust  
Dryer output capacity:  
8,5 t/h from 50% - 10%



Project: Ziegler  
Germany, Plößberg  
Type: BT 1/6200-40,5  
Year: 2007  
Product: sawdust  
Dryer output capacity:  
13,5 t/h from 50% - 10%





Project: Schweighofer  
Rumania, Sebes  
Type: BT 1/6200-25,5  
Year: 2007  
Product: sawdust  
Dryer output capacity:  
8,0 t/h from 50% - 10%



Project: Pfeifer Holz GmbH  
Germany, Unterbernbach  
Type: 4x BT 1/6200-36  
Year: 2007  
Product: sawdust  
Dryer output capacity:  
50,0 t/h from 50% - 3%



Project: Hasslacher  
Preding Holzindustrie  
GmbH Austria, Preding  
Type: BT 1/6200-22,5  
Year: 2007  
Product: sawdust  
Dryer output capacity:  
8,5 t/h from 50% - 10%



Project: German Pellets  
Germany, Ettenheim II  
Type: 2x BT 1/6200-22,5  
Year: 2006  
Product: wood chips  
Dryer output capacity:  
per 6,5 t/h from 50% - 10%





Project: ERDA Belgium,  
Bertrix  
Type: 2x BT 1/6200-27  
Year: 2006  
Product: sawdust  
Dryer output capacity:  
per 16,0 t/h from 50% - 10%



Project: Delhez  
Belgium, Dison  
Type: BT 1/6200-33  
Year: 2006  
Product: wood shavings  
Dryer output capacity:  
12,0 t/h from 50% - 10%



Project: UET Choren  
Germany, Freiberg  
Type: BT 1/6200-12  
Year: 2006  
Product: wood chips  
Dryer output capacity:  
4,5 t/h from 35% - 10%



Project: Sägewerk  
Schwaiger  
Germany, Hengersberg  
Type: BT 1/6200-33  
Year: 2006  
Product: sawdust  
Dryer output capacity:  
10,5 t/h from 50% - 10%





Project: Firestix  
Salzburg-Pellet  
Produktion GmbH  
Austria, Abtenau  
Type: BT1/6200-16,5  
Year: 2004  
Product: sawdust  
Dryer output capacity:  
5,0 t/h from 50% - 10%



Project: Holz Schiller GmbH  
Germany, Regen  
Type: BT 1/2700-10  
Year: 2004  
Product: sawdust  
Dryer output capacity:  
1,5 t/h from 50% - 10%



Projekt: Baust Holztechnik  
GmbH Germany,  
Eslohe-Bremke  
Year: 2003  
Type: BT 1/2700-12  
Product: sawdust  
Dryer output capacity:  
2,0 t/h from 50% - 10%



Project: Pollmeier  
Germany, Malchow  
Type: BT 1/2700-13  
Year: 2003  
Product: sawdust  
Dryer output capacity:  
2,4 t/h from 45% - 8%



# Low-temperature sewage sludge belt drier





## STELA - Low-temperature sewage sludge belt drier

STELA is a medium-sized family-owned enterprise with an experience of more than 40 years in the technology of low-temperature drying.

With the STELA sewage sludge drier, the most various sludges are dried in a reliable, energy-saving and dust-free way to DS contents up to a dry substance of 95 %.

The mechanically dewatered sewage sludge is extruded on a purpose-built granulator. Subsequently, the product falls directly onto a perforated conveyor belt and forms a pile with good ventilation. The product is brought into the drier tunnel, where hot air flows through it drying it efficiently.

This process avoids mechanical product stress as far as possible

### Decisive characteristics of our drying plants

- product turning device for a constant final moisture and easy ventilation of the product
- low thermal and electrical energy consumption by means of a proven air circulation system and optimally synchronized components
- drier sizes individually adaptable to the particular conditions and designed in three different belt widths for individual adaptation to the customer demands

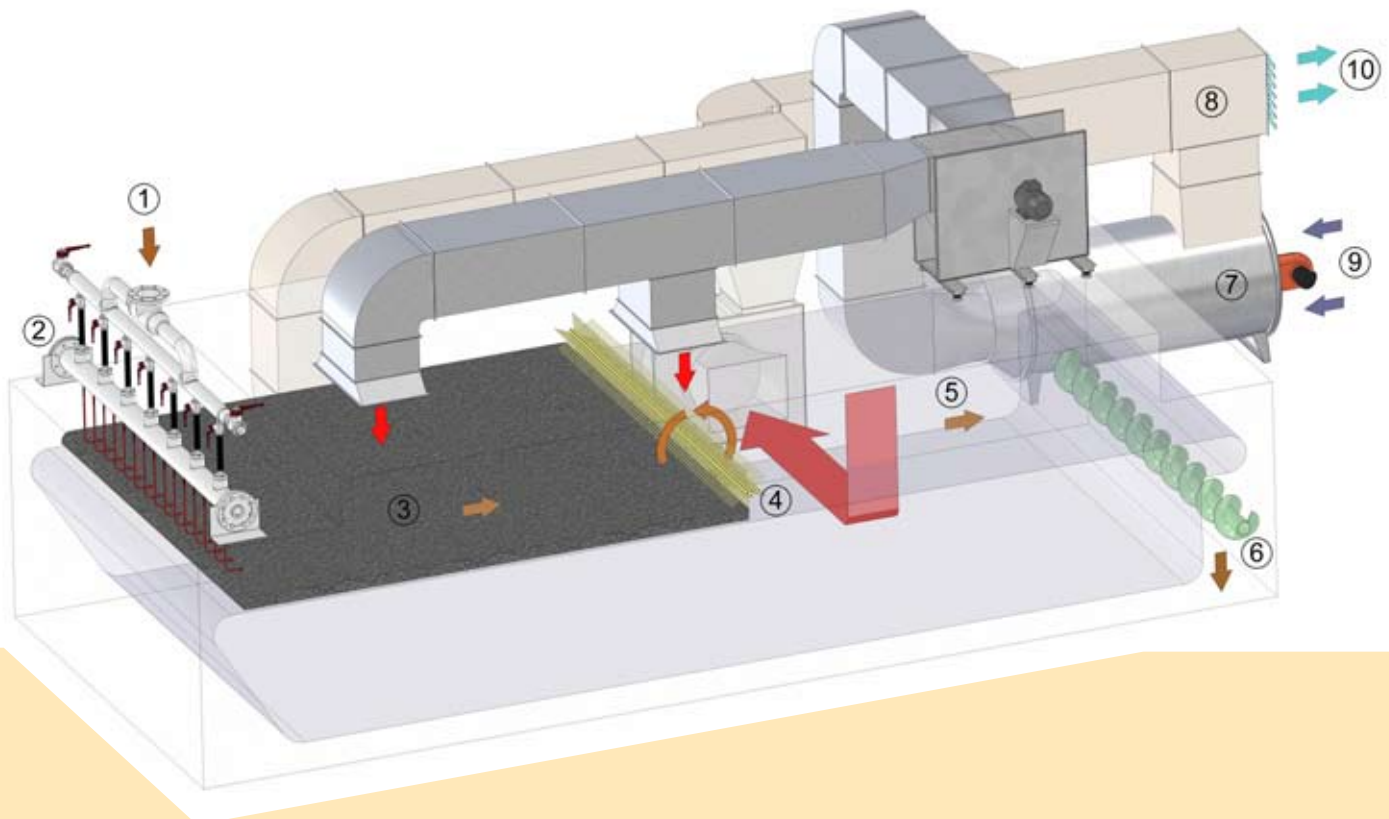

- |                                      |                            |
|--------------------------------------|----------------------------|
| 1 = product infeed                   | 6 = discharge screw        |
| 2 = granulator                       | 7 = hot air generation     |
| 3 = product                          | 8 = circulation air system |
| 4 = turning device                   | 9 = fresh air              |
| 5 = web belt or stainless steel belt | 10 = exhaust air           |

## STELA - Low-temperature sewage sludge belt drier



Type: PBT 1/2500-17, water evaporation 1.000 kg/h



Type: PBT 1/2500-12, water evaporation 1.250 kg/h



Type: PBT 2/2500-24, water evaporation 3.000 kg/h

- water evaporation rates of 0.2 – 6 t/h or more
- more than 400 belt driers in the most various sizes installed all over the world
- single-belt drier or two-belt drier depending on the location
- exhaust air scrubber for every plant size
- turnkey belt driers including exhaust air conditioning

- special granulating unit without product remixing
- use of low-caloric heat
- reliable and approved drying technology
- high-quality and flexible order processing on schedule due to in-house production by qualified STELA staff



flow sheet

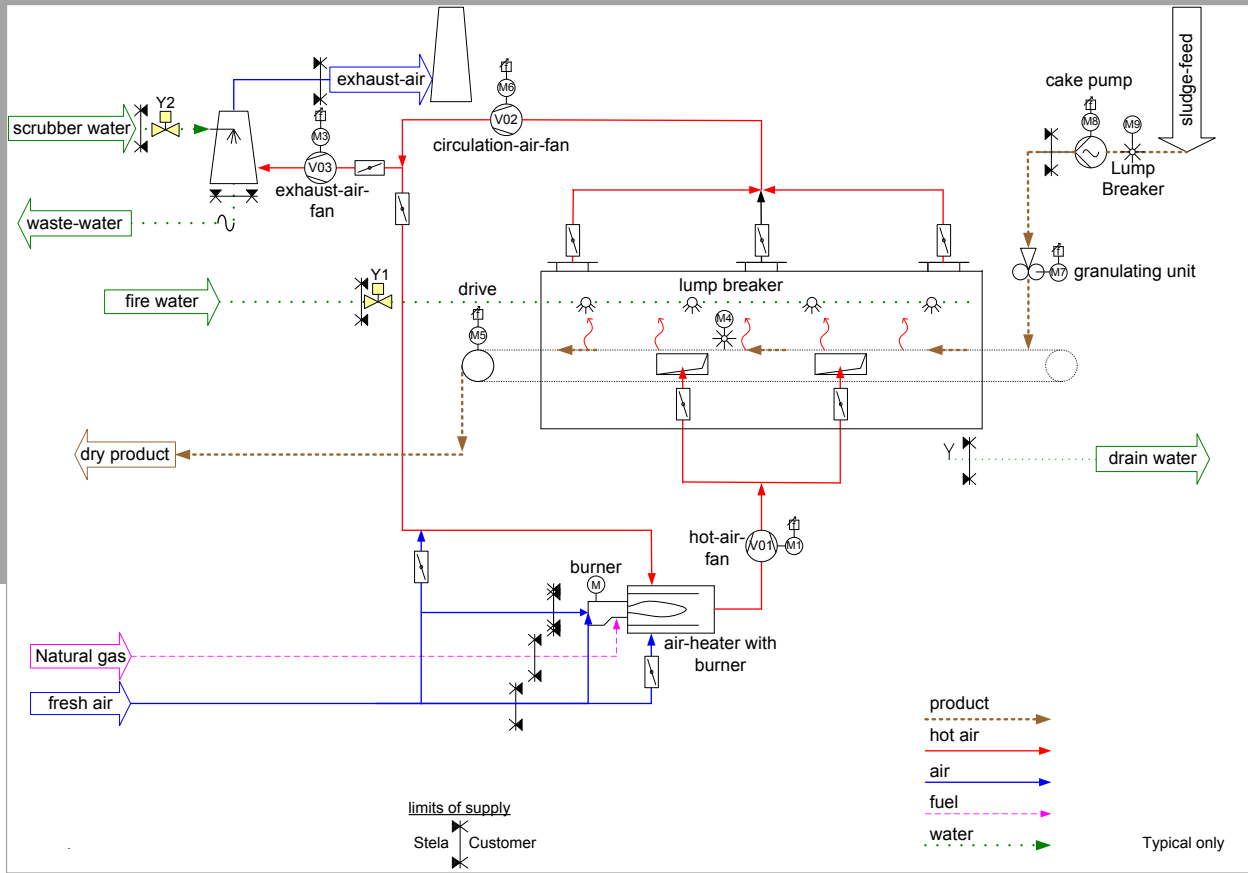

[www.ispm-service.com](http://www.ispm-service.com)

## PORTUGAL

+351 234 304 197  
Rua Dr. Alberto Soares Machado, 89  
Apartado 512, EC Avenida  
3801-901 Aveiro | Portugal

[ispm@ispm-service.pt](mailto:ispm@ispm-service.pt)

## FRANÇA

+33 1 43 34 81 72  
+33 6 11 10 50 91  
5 Place Charras Apt 67  
92.400 Courbevoie | France

[drousseau@ispm-service.pt](mailto:drousseau@ispm-service.pt)

## BRASIL

+55 31 2527 4426  
Três Corações, 136/1004  
Belo Horizonte - MG  
30411-239 | Brasil

[dieter.dombrowski@ispm-service.pt](mailto:dieter.dombrowski@ispm-service.pt)

